

4.0 **DESIGNAZIONE**

4.0 **DESIGNATION**

4.0 **BEZEICHNUNG**

4.0 **DESIGNATION**

4.1 **Designazione riduttore**

4.1 **Gearbox designation**

4.1 **Getriebe-bezeichnung**

4.1 **Désignation réducteur**

VF 49 L1 F1 — 28 P63 B5 B3

OPZIONI / OPTIONS
OPTIONEN / OPTIONS (4.3)

ESECUZIONE DI MONTAGGIO / MOUNTING ARRANGEMENT
BAUFORM / ASSEMBLAGE (3.0)
(solo per / only for / nur für / seulement pour VF/VF)

POS. DI MONTAGGIO / MOUNTING POSITION
EINBAULAGEN / POS. DE MONTAGE
B3 (Standard), **B6, B7, B8, V5, V6**

FORMA COSTRUTTIVA DEL MOTORE / MOTOR MOUNTING
MOTOR BAUFORM / FORME DE CONSTRUCTION DU MOTEUR
B5 (IEC standard VF 30 - VF 250, VFR 49 - VFR 250)
B14 (a richiesta / on request / au anfrage / sur demande VF30 - VF110)

DESIGNAZIONE INGRESSO / INPUT DESIGNATION
BEZEICHNUNG DER ANTRIEBSSEITE / DESIGNATION ENTREE

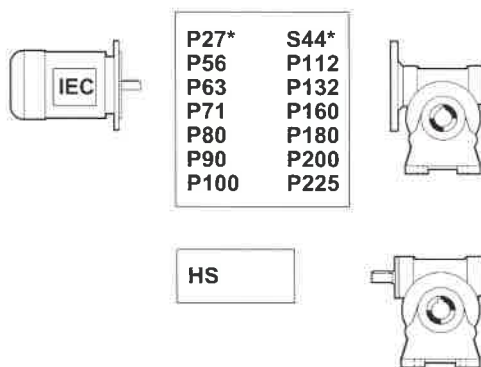

* **P27** = VF 27 predisposto per motore speciale BN27.
VF 27 only for combination with motor BN27.
VF 27 für Spezialmotor BN27 vorbereitet.

** **S44** = Riduttore VFR 44 fornito solo con motore compatto speciale BN44.
VF 27 pour moteur spécial BN27.

VFR 44 gearbox supplied with dedicated compact motor BN44 only.
Getriebe VFR 44, wird nur mit kompaktem Spezialmotor BN44 geliefert.
Réducteur VFR 44 fourni uniquement avec moteur compact spécial BN44.

RAPPORTO DI RIDUZIONE / GEAR RATIO
ÜBERSETZUNG / RAPPORT DE REDUCTION

DIAMETRO ALBERO LENTO/OUTPUT SHAFT BORE
DIAMETERDURCHMESSER DER ABTRIEBSWELLE/DIAMETRE ARBRE LENT
(Solo per VF 72 - std.=28, a rich. 30)/(For VF 72 only - std.=28, 30 on request)
(Nur für VF 72 - Standard. = 28 Durchmesser, Optional 30 Durchmesser)/(seulement pour VF 72 - std = 28, sur demande 30)

FORMA COSTRUTTIVA / VERSION / BAUFORM / FORME DE CONSTRUCTION

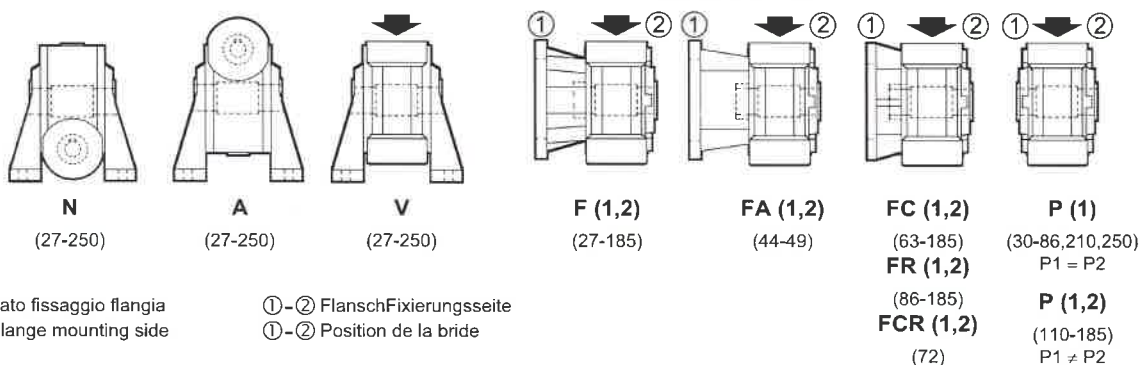

LIMITATORE DI COPPIA (se richiesto)/TORQUE LIMITER (if requested)
DREHMOMENTBEGRENZER (auf Anfrage)/ LIMITEUR DE COUPLE (s'il est requis) (19.0)
L1 / L2 / LF = vedi pag. 173 / see page 173 / siehe Seite 173/ voir à la page 173

GRANDEZZA RIDUTTORE / GEARBOX SIZE / GETRIEBEBAUGRÖSSE / TAILLE REDUCTEUR

27, 30, 44, 49, 63, 72, 86, 110, 130, 150, 185, 210, 250 (VF)
44, 49, 63, 72, 86, 110, 130, 150, 185, 210, 250 (VFR)
30/44, 30/49, 30/63, 44/72, 44/86, 49/110, 63/130, 86/150, 86/185, 130/210, 130/250 (VF/VF)

TIPO RIDUTTORE:	VF = Riduttore a vite senza fine	VFR = Riduttore con precoppia	VF/VF = Riduttore combinato
GEARBOX TYPE:	VF = Worm gearbox	VFR = Helical-worm gear unit	VF/VF = Combined gearbox
GETRIEBETYP:	VF = Schneckengetriebe	VFR = Schneckengetriebe mit eingangsseitiges Stirnradstufe	VF/VF = Doppelschneckengetriebe
TYPE DE REDUC.:	VF = Réducteur a vis sans fin	VFR = Réducteur avec pré-étage	VF/VF = Réducteur combiné

2.0 FORME COSTRUTTIVE

2.0 VERSIONS

Di seguito sono indicate le forme costruttive disponibili per i riduttori, motoriduttori serie VF ,VFR e VF/VF.

Available versions for VF, VFR and VF/VF series gearbox and gearmotors are shown below.

2.0 BAUFORMEN

Im folgenden werden die für die Getriebe und Getriebemotoren der Serie VF, VFR und VF/VF lieferbaren Bauformen angegeben.

2.0 FORMES DE CONSTRUCTION

Ci-dessous sont indiquées les formes de construction disponibles pour les réducteurs et les motoréducteurs série VF, VFR et VF/VF.

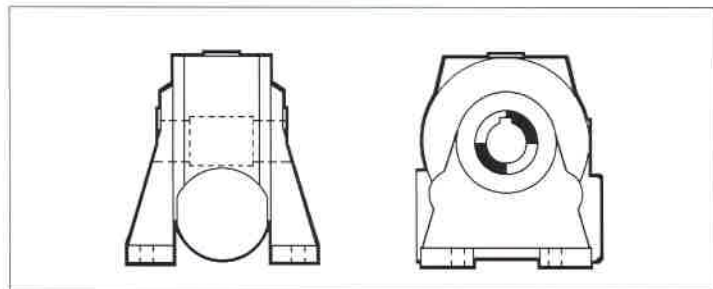

N

Con piedi e vite orizzontale in basso
Foot mounted, underdriven
Mit Füßen und untenliegendet Schneckenwelle
Avec pattes et vis horizontale en bas

VF27-VF250

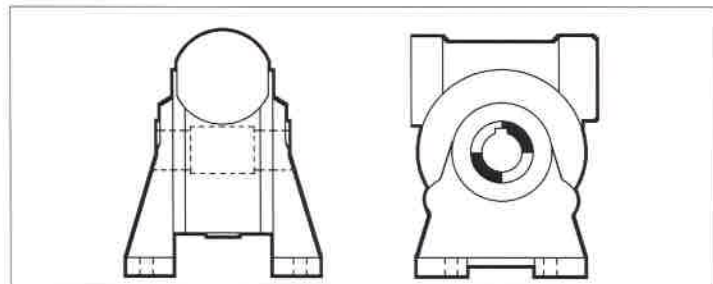

A

Con piedi e vite orizzontale in alto
Foot mounted, overdriven
Mit Füßen und Schneckenwelle oben
Avec pattes et vis horizontale en haut

VF27-VF250

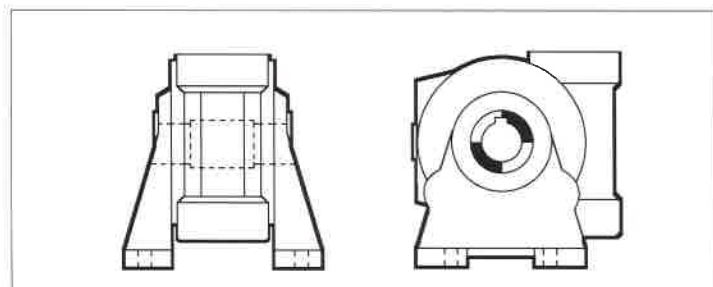

V

Con piedi e vite verticale
Foot mounted, wormshaft vertical
Mit Füßen und senkrechter Schneckenwelle
Avec pattes et vis verticale

VF27-VF250

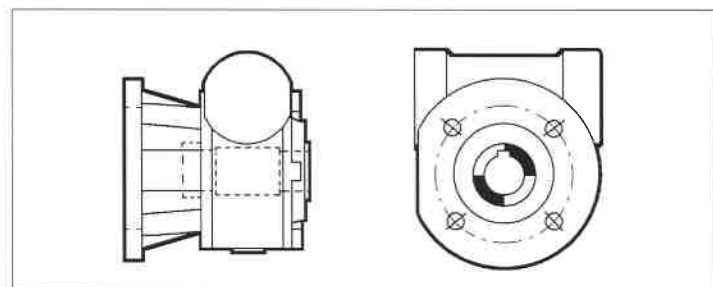

F

Con flangia standard
With standard flange
Mit Standardflansch
Avec bride standard

VF27-VF185

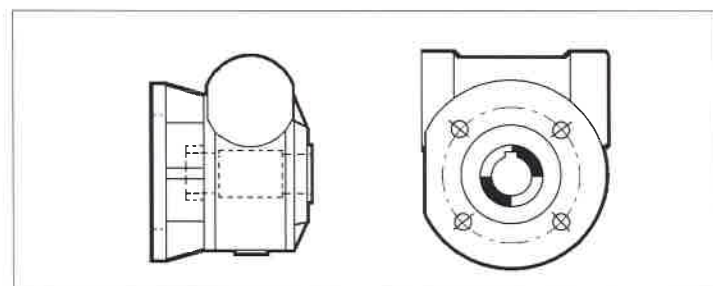

FA

Con flangia alta
Extended o/p flange
Mit hohem Flansch
Avec bride haute

VF44-VF49

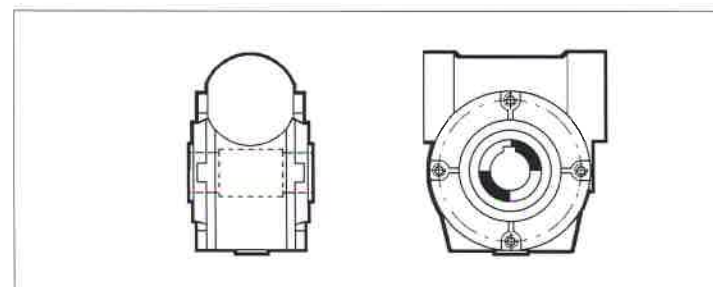

FC

Con flangia corta
With short flange
Mit kurzem Flansch
Avec bride courte

VF63-VF185

FCR

Con flangia corta con diametro ridotto
With reduced diameter short flange
Kurze Flansch mit geringem Durchmesser
Avec bride courte et diamètre réduit

VF72

FR

Con flangia corta e cuscinetti rinforzati
With short flange and reinforced bearings
Kurze Flansch und verstärkten Lagern
Avec bride courte et roulements renforcés

VF86-VF185

P

Con flangia pendolare
Side cover for shaft mounting
Mit Flansch für Drehmomentstütze
Avec bride pendulaire

VF30-VF250

6.2 Posizioni di montaggio serie VF

6.2 Mounting position VF gearmotors

6.2 Einbaulagen serie VF

6.2 Positions de montage serie VF

Il seguente schema si applica anche al riduttore finale dei gruppi combinati tipo VF/VF.

The following diagram also applies to the primary unit of combined VF/VF gearboxes.

Das folgende Diagramm ist auch für das Haupteinheit der kombinierten Getrieben VF/VF gültig.

Le tableau suivante se réfère aussi au réducteur primaire du combiné VF/VF.

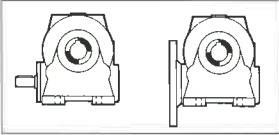
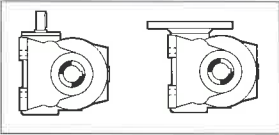
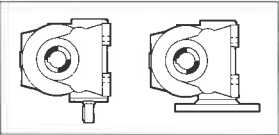
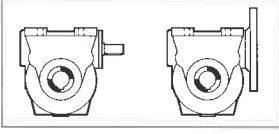
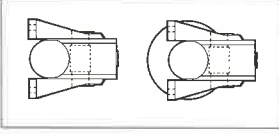
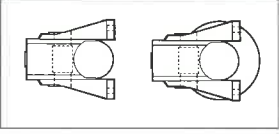
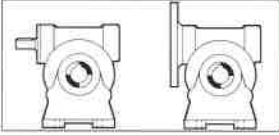
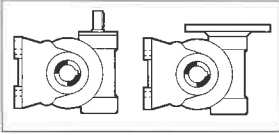
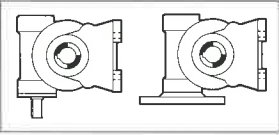
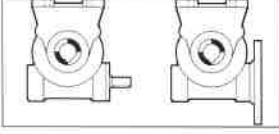
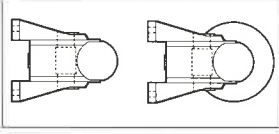
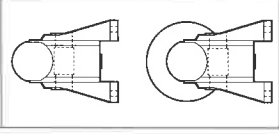
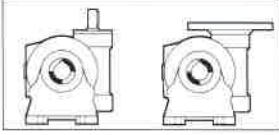
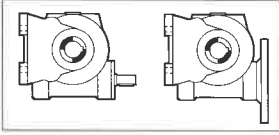
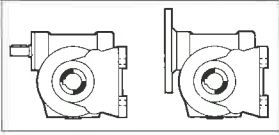
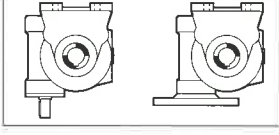
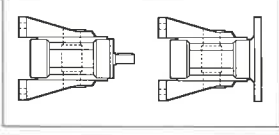
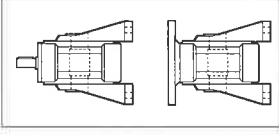
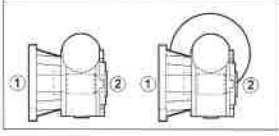
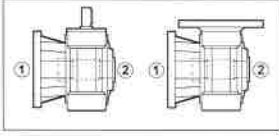
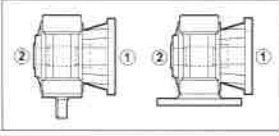
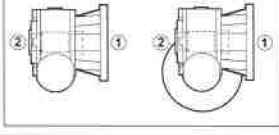
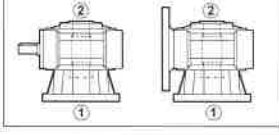
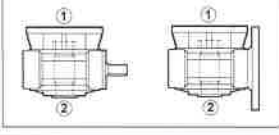
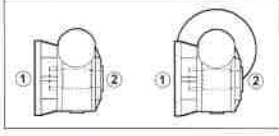
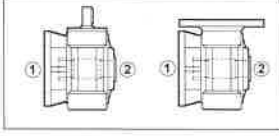
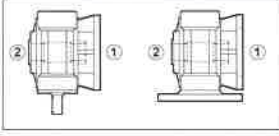
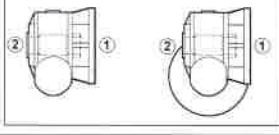
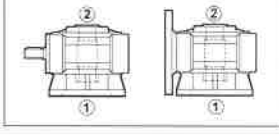
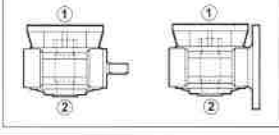
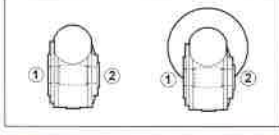
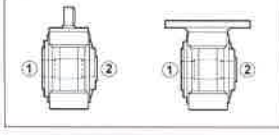
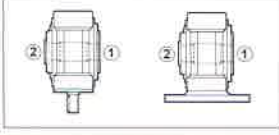
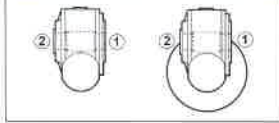
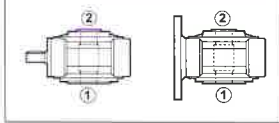
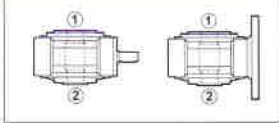

(V14)

① ② Posizione flangia / Flange position / Flanschlage / Position bride

N		B3		V6		V5
		B8		B6		B7
A		B3		V6		V5
		B8		B6		B7
V		B3		V6		V5
		B8		B6		B7
F - FA		B3		V6		V5
		B8		B6		B7
FC - FR- FCR		B3		V6		V5
		B8		B6		B7
P		B3		V6		V5
		B8		B6		B7

VF 72



280 Nm

	i	η_s %	n_2	M_{n2}	P_{n1}	R_{n1}	R_{n2}	η_d	n_2	M_{n2}	P_{n1}	R_{n1}	R_{n2}	η_d		
			min ⁻¹	Nm	kW	N	N	%	min ⁻¹	Nm	kW	N	N	%		
			$n_1 = 2800 \text{ min}^{-1}$						$n_1 = 1400 \text{ min}^{-1}$							
VF 72_7	7	71	400	128	6.0	750	1470	89	200	170	4.0	750	1810	88	166	VFH070
VF 72_10	10	67	280	143	4.8	750	1860	88	140	190	3.2	750	2280	86	166	VFH070
VF 72_15	15	60	187	143	3.3	750	2380	85	93	190	2.2	750	2930	83	166	VFH070
VF 72_20	20	56	140	143	2.5	750	2750	83	70	190	1.7	750	3410	80	166	VFH070
VF 72_25	25	52	112	143	2.1	750	3060	81	56	190	1.4	750	3800	78	166	VFH070
VF 72_30	30	45	93	150	1.9	750	3270	78	47	200	1.2	750	4060	74	166	VFH070
VF 72_40	40	40	70	143	1.4	750	3750	75	35	190	0.96	750	4670	70	166	VFH070
VF 72_50	50	36	56	128	1.0	750	4200	72	28.0	170	0.73	750	5250	67	166	VFH070
VF 72_60	60	33	47	120	0.85	750	4560	69	23.3	160	0.60	750	5250	63	166	VFH070
VF 72_80	80	28	35	113	0.65	750	5140	64	17.5	150	0.45	750	5250	58	166	VFH070
VF 72_100	100	25	28	98	0.49	750	5250	59	14.0	130	0.35	750	5250	53	166	VFH070

			$n_1 = 900 \text{ min}^{-1}$						$n_1 = 500 \text{ min}^{-1}$							
VF 72_7	7	71	129	200	3.1	750	2100	86	71	240	2.1	750	2590	84	166	VFH070
VF 72_10	10	67	90	220	2.5	750	2640	84	50	270	1.7	750	3190	82	166	VFH070
VF 72_15	15	60	60	220	1.7	750	3400	80	33	270	1.2	750	4120	77	166	VFH070
VF 72_20	20	56	45	220	1.3	750	3950	77	25.0	270	0.97	750	4790	74	166	VFH070
VF 72_25	25	52	36	220	1.1	750	4400	75	20.0	270	0.81	750	5340	71	166	VFH070
VF 72_30	30	45	30.0	240	1.1	750	4660	70	16.7	280	0.75	750	5730	66	166	VFH070
VF 72_40	40	40	22.5	220	0.78	750	5420	66	12.5	270	0.58	750	5750	61	166	VFH070
VF 72_50	50	36	18.0	190	0.58	750	5500	62	10.0	220	0.40	750	5750	57	166	VFH070
VF 72_60	60	33	15.0	180	0.49	750	5500	59	8.3	210	0.34	750	5750	54	166	VFH070
VF 72_80	80	28	11.3	150	0.34	750	5500	53	6.3	180	0.25	750	5750	48	166	VFH070
VF 72_100	100	25	9.0	140	0.27	750	5500	48	5.0	170	0.20	750	5750	43	166	VFH070

VF 86

430 Nm

	i	η_s %	n_2	M_{n2}	P_{n1}	R_{n1}	R_{n2}	η_d	n_2	M_{n2}	P_{n1}	R_{n1}	R_{n2}	η_d		
			min ⁻¹	Nm	kW	N	N	%	min ⁻¹	Nm	kW	N	N	%		
			$n_1 = 2800 \text{ min}^{-1}$						$n_1 = 1400 \text{ min}^{-1}$							
VF 86_7	7	71	400	184	8.6	850	1120	90	200	245	5.8	850	1340	88	166	VFH090
VF 86_10	10	67	280	203	6.7	850	1790	89	140	270	4.6	850	2160	87	166	VFH090
VF 86_15	15	60	187	218	5.0	850	2280	86	93	290	3.4	850	2790	84	166	VFH090
VF 86_20	20	60	140	210	3.6	850	2720	85	70	280	2.5	850	3340	83	166	VFH090
VF 86_23	23	58	122	210	3.2	850	2930	84	61	280	2.2	850	3610	81	166	VFH090
VF 86_30	30	45	93	248	3.0	850	3150	80	47	330	2.2	850	3880	75	166	VFH090
VF 86_40	40	45	70	240	2.3	850	3690	78	35	320	1.6	850	4560	74	166	VFH090
VF 86_46	46	43	61	233	2.0	850	3960	76	30.0	310	1.5	850	4920	72	166	VFH090
VF 86_56	56	39	50	206	1.5	850	4450	74	25.0	275	1.1	850	5540	69	166	VFH090
VF 86_64	64	37	44	206	1.3	850	4710	72	21.9	275	0.90	850	5860	67	166	VFH090
VF 86_80	80	33	35	191	1.0	850	5220	68	17.5	255	0.75	850	6300	63	166	VFH090
VF 86_100	100	29	28	173	0.79	850	5780	64	14.0	230	0.60	850	6300	58	166	VFH090

			$n_1 = 900 \text{ min}^{-1}$						$n_1 = 500 \text{ min}^{-1}$							
VF 86_7	7	71	129	280	4.3	850	1730	87	71	360	3.2	850	1970	85	166	VFH090
VF 86_10	10	67	90	300	3.3	850	2590	85	50	360	2.3	850	3180	82	166	VFH090
VF 86_15	15	60	60	330	2.6	850	3260	81	33	390	1.7	850	4030	78	166	VFH090
VF 86_20	20	60	45	310	1.8	850	3950	80	25.0	390	1.3	850	4730	77	166	VFH090
VF 86_23	23	58	39	300	1.6	850	4310	79	21.7	360	1.1	850	5270	75	166	VFH090
VF 86_30	30	45	30.0	360	1.6	850	4610	72	16.7	430	1.1	850	5640	67	166	VFH090
VF 86_40	40	45	22.5	340	1.1	850	5430	70	12.5	390	0.77	850	6720	66	166	VFH090
VF 86_46	46	43	19.6	330	1.0	850	5830	68	10.9	390	0.70	850	7000	63	166	VFH090
VF 86_56	56	39	16.1	310	0.80	850	6450	65	8.9	360	0.56	850	7000	60	166	VFH090
VF 86_64	64	37	14.1	290	0.70	850	6600	62	7.8	360	0.51	850	7000	58	166	VFH090
VF 86_80	80	33	11.3	270	0.54	850	6600	58	6.3	290	0.36	850	7000	53	166	VFH090
VF 86_100	100	29	9.0	240	0.41	850	6600	54	5.0	290	0.31	850	7000	49	166	VFH090

VF 86A..P(IEC)

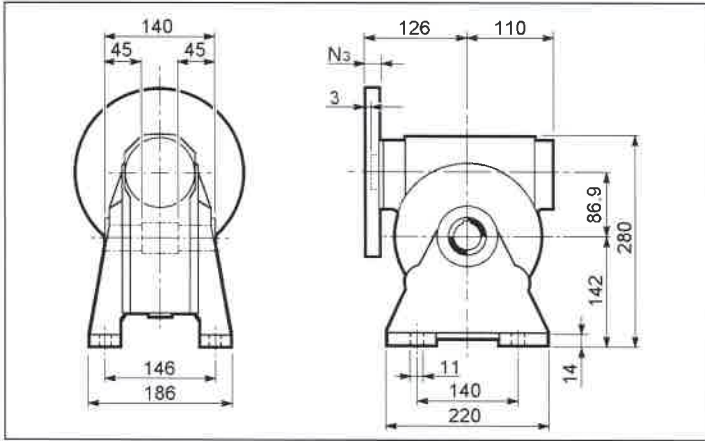

VF 86F..P(IEC)

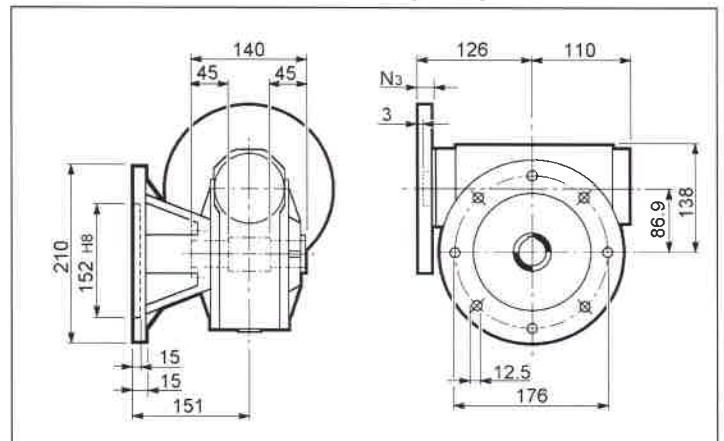

VF 86N..P(IEC)

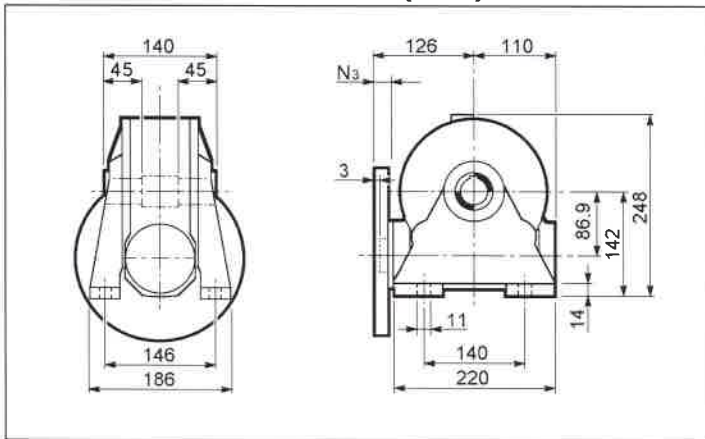

VF 86FC (FR)..P(IEC)

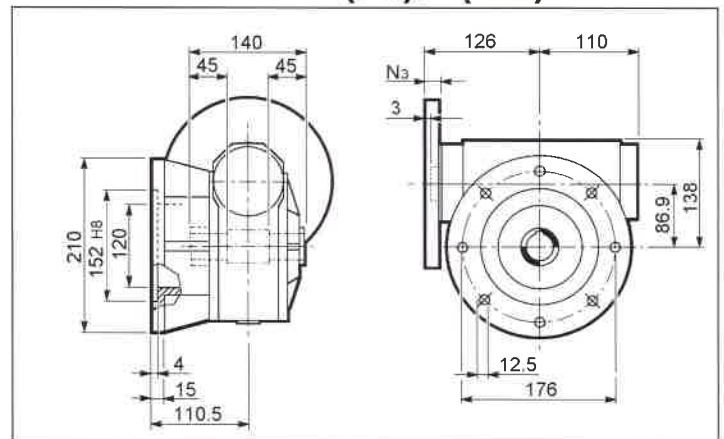

VF 86V..P(IEC)

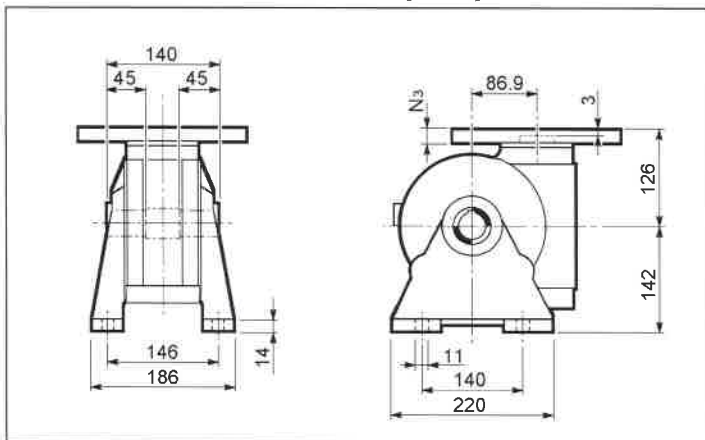

VF 86P..P(IEC)

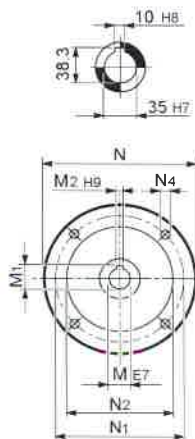
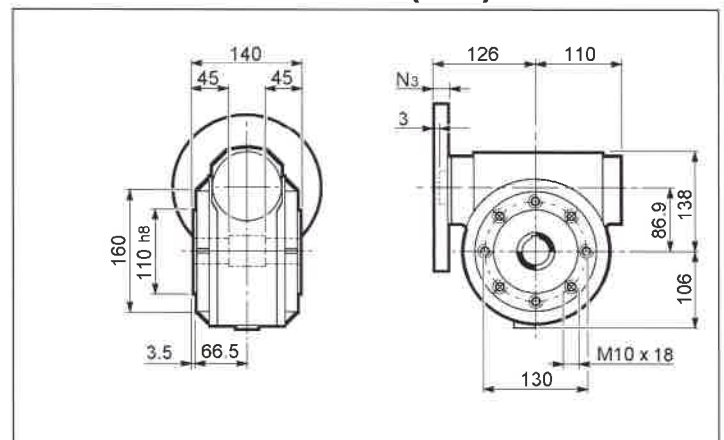

VF 86									
	M	M₁	M₂	N	N₁	N₂	N₃	N₄	⊙ Kg
VF 86_P 71 B5	14	16.3	5	160	130	110	12	9	16.3
VF 86_P 80 B5	19	21.8	6	200	165	130	12	11.5	
VF 86_P 90 B5	24	27.3	8	200	165	130	12	11.5	
VF 86_P 100 B5	28	31.3	8	250	215	180	13	13.5	
VF 86_P 112 B5	28	31.3	8	250	215	180	13	13.5	
VF 86_P 80 B14	19	21.8	6	120	100	80	10	7	
VF 86_P 90 B14	24	27.3	8	140	115	95	10	9	
VF 86_P 100 B14	28	31.3	8	160	130	110	12	9	
VF 86_P 112 B14	28	31.3	8	160	130	110	12	9	