



BSC201

Benchtop Stepper Motor Controller

User Guide



Original Instructions

---

---

# Contents

<b>Chapter 1 Safety</b> .....	<b>3</b>
1.1 Safety Information .....	3
1.2 General Warnings .....	3
<b>Chapter 2 Overview</b> .....	<b>4</b>
2.1 Introduction .....	4
2.2 APT PC Software Overview .....	6
<b>Chapter 3 Getting Started</b> .....	<b>11</b>
3.1 Installing APT Software .....	11
3.2 Mechanical Installation .....	12
3.3 Electrical Installation .....	13
3.4 Front Panel Controls and Indicators .....	15
3.5 Connecting The Hardware .....	15
3.6 Select the Stage Type (Using APTConfig) .....	16
3.7 Verifying Software Operation .....	17
<b>Chapter 4 Operation - Tutorial</b> .....	<b>18</b>
4.1 Introduction .....	18
4.2 Using the APT User Utility .....	18
4.3 Homing Motors .....	19
4.4 Moving to an Absolute Position .....	20
4.5 Stopping the Stage.....	20
4.6 Changing Motor Parameters .....	21
4.7 Jogging .....	22
4.8 Graphical Control Of Motor Positions (Point and Move) .....	23
4.9 Setting Move Sequences .....	25
4.10 Using A Joystick Console.....	28
4.11 Creating a Simulated Configuration Using APT Config .....	29
4.12 Stage/Axis Tab .....	32
<b>Chapter 5 Software Reference</b> .....	<b>33</b>
5.1 Introduction .....	33
5.2 GUI Panel .....	33
5.3 Settings Panel .....	35
<b>Appendix A Rear Panel Connector Pinout Details</b> .....	<b>46</b>
<b>Appendix B Using A Virtual Comm Port</b> .....	<b>52</b>
<b>Appendix C Preventive Maintenance</b> .....	<b>55</b>
<b>Appendix D Specifications and Associated Products</b> .....	<b>56</b>
<b>Appendix E Motor Control Method Summary</b> .....	<b>58</b>
<b>Appendix F Stepper Motor Operation - Background</b> .....	<b>62</b>
<b>Appendix G Regulatory</b> .....	<b>68</b>
<b>Appendix H Thorlabs Worldwide Contacts</b> .....	<b>71</b>







---

# Chapter 1 Safety



## 1.1 Safety Information



For the continuing safety of the operators of this equipment, and the protection of the equipment itself, the operator should take note of the **Warnings, Cautions** and **Notes** throughout this handbook and, where visible, on the product itself.

The following safety symbols may be used throughout the handbook and on the equipment itself.

	<b>Shock Warning</b>	
Given when there is a risk of injury from electrical shock.		
	<b>Warning</b>	
Given when there is a risk of injury to users.		
	<b>Caution</b>	
Given when there is a risk of damage to the product.		
<b>Note</b>		
Clarification of an instruction or additional information.		

## 1.2 General Warnings

	<b>Warnings</b>	
If this equipment is used in a manner not specified by the manufacturer, the protection provided by the equipment may be impaired. In particular, excessive moisture may impair operation.		
Spillage of fluid, such as sample solutions, should be avoided. If spillage does occur, clean up immediately using absorbant tissue. Do not allow spilled fluid to enter the internal mechanism.		

	<b>Caution</b>	
If your PC becomes unresponsive (e.g due to an operating system problem, entering a sleep state condition, or screen saver operation) for a prolonged period, this will interrupt communication between the APT Software and the hardware, and a communications error may be generated. To minimize the possibility of this happening it is strongly recommended that any such modes that result in prolonged unresponsiveness be disabled before the APT software is run. Please consult your system administrator or contact Thorlabs technical support for more details.		

---

## Chapter 2 Overview

### 2.1 Introduction

The BSC201 single channel APT Stepper Motor Controller is the next generation of enhanced controllers using the familiar APTUser interface. Many new features are provided, including a choice between trapezoidal and S-shaped velocity profiles, a higher theoretical microstep resolution (409600 for a 200 full step motor) and speeds more than twice that achieved by its predecessors.

The apt stepper motor controller is supplied with a full suite of software support tools. An intuitive graphical instrument panel allows immediate control and visualization of the operation of the stepper controllers, and any other controllers that are installed in the system. See Chapter 5 for a full description of the apt system software.



**Fig. 2.1 APT Single Channel Stepper Motor Controller (BSC201)**

Stepper motors give excellent low speed performance and positioning stability compared with DC servo motors. A wide range of 2-phase bipolar stepper motors and associated actuators are commercially available, each with its own characteristics, such as step resolution, peak phase current or voltage, and lead screw pitch. For this reason the apt™ stepper unit operation is fully configurable (parameterized) with key settings exposed through the associated graphical interface panels.

Motor step resolution, and lead screw pitch can be set for a particular motor/actuator combination, phase currents can be limited to suitable peak powers as required, and limit switch configuration is accommodated through a flexible set of limit switch logic settings. Moreover, relative and absolute moves can be initiated with move profiles

set using velocity profile parameters. The inclusion of a 'Bow Index' parameter within these settings enables the choice of trapezoidal or S-curve velocity profiles.

Similarly, home sequences have a full set of associated parameters that can be adjusted for a particular stage or actuator. For simplicity of operation, the apt™ software incorporates pre-configured settings for each of the Thorlabs stages and actuators, while still exposing all parameters individually for use with other stepper motor driven systems.

For convenience and ease of use, adjustment of many key parameters is possible through direct interaction with the graphical panel. For example a move to the next position can be initiated by clicking directly on the position display and entering a new value (see the tutorial in Chapter 4 for further details). Furthermore, all such settings and parameters are also accessible through the ActiveX® programmable interfaces for automated alignment sequences.

The apt™ stepper unit also supports encoder feedback through dedicated quadrature encoded pulse (QEP) inputs, one for each channel of operation. Through conversion routines, the apt™ software is able to use this feedback signal to generate encoder position for access either through the GUI or via programmable interfaces for custom closed loop algorithms. A "built in" algorithm can be enabled to allow the stepper system to reach and maintain an encoded position through an iterative move sequence. Please see the handbook supplied with your linear encoded stage for further details.

In the remainder of this handbook, the Tutorial section (Chapter 4) provides a good initial understanding on using the unit, and the reference sections (Chapter 5) covers all operating modes and parameters in detail.

## 2.2 APT PC Software Overview

### 2.2.1 Introduction

As a member of the APT range of controllers, the BSC201 stepper controller shares many of the associated software benefits. This includes USB connectivity (allowing multiple units to be used together on a single PC), fully featured Graphical User Interface (GUI) panels, and extensive software function libraries for custom application development.

The APT software suite supplied with all APT controllers, including the BSC201 stepper controller, provides a flexible and powerful PC based control system both for users of the equipment, and software programmers aiming to automate its operation.

For users, the APTUser (see Section 2.2.2.) and APTConfig (see Section 2.2.3.) utilities allow full control of all settings and operating modes enabling complete 'out-of-box' operation without the need to develop any further custom software. Both utilities are built on top of a sophisticated, multi-threaded ActiveX 'engine' (called the APT server) which provides all of the necessary APT system software services such as generation of GUI panels, communications handling for multiple USB units, and logging of all system activity to assist in hardware trouble shooting. It is this APT server 'engine' that is used by software developers to allow the creation of advanced

automated positioning applications very rapidly and with great ease. The APT server is described in more detail in Section 2.2.4.

*Aside*

*ActiveX®, a Windows®-based, language-independent technology, allows a user to quickly develop custom applications that automate the control of APT system hardware units. Development environments supported by ActiveX® technology include Visual Basic®, LabView™, Borland C++ Builder, Visual C++, Delphi™, and many others. ActiveX® technology is also supported by .NET development environments such as Visual Basic.NET and Visual C#.NET.*

*ActiveX controls are a specific form of ActiveX technology that provide both a user interface and a programming interface. An ActiveX control is supplied for each type of APT hardware unit to provide specific controller functionality to the software developer. See Section 2.2.4. for further details.*

**2.2.2 APTUser Utility**

The APTUser application allows the user to interact with a number of APT hardware control units connected to the host PC. This program displays multiple graphical instrument panels to allow multiple APT units to be controlled from the same screen.



All basic operating parameters can be altered and, similarly, all operations (such as motor moves) can be initiated. Settings and parameter changes can be saved and loaded to allow multiple operating configurations to be created and easily applied.

For many users, the APTUser application provides all of the functionality necessary to operate the APT hardware without the need to develop any further custom

software. For those who do need to further customise and automate usage of the controller (e.g. to implement a positioning algorithm), this application illustrates how the rich functionality provided by the APT ActiveX server is exposed by a client application. The complete Visual Basic source project is provided as a useful aid to software developers.

Use of the APT User utility is covered in the PC tutorial (Chapter 4) and in the APTUser online help file, accessed via the F1 key when using the APTUser utility.

### 2.2.3 APT Config Utility

There are many system parameters and configuration settings associated with the operation of the APT Server. Most can be directly accessed using the various graphical panels, however there are several system wide settings that can be made 'off-line' before running the APT software. These settings have global effect; such as switching between simulator and real operating mode, associating mechanical stages to specific motor actuators and incorporation of calibration data.

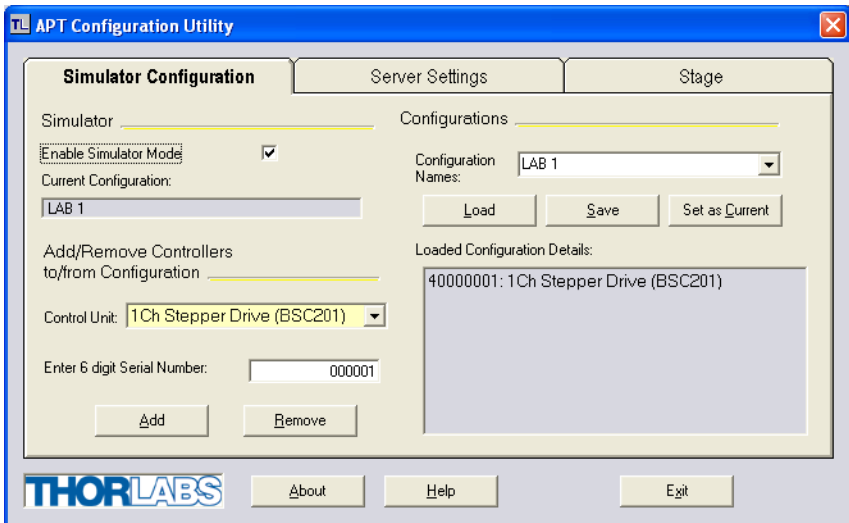

The APTConfig utility is provided as a convenient means for making these system wide settings and adjustments. Full details on using APTConfig are provided in the online help supplied with the utility.

Use of the APT Config utility is covered in the PC tutorial (Chapter 4) and in the APTConfig online help file, accessed via the F1 key when using the APTConfig utility.

### 2.2.4 APT Server (ActiveX Controls)

ActiveX Controls are re-usable compiled software components that supply both a graphical user interface and a programmable interface. Many such Controls are available for Windows applications development, providing a large range of re-usable functionality. For example, there are Controls available that can be used to manipulate image files, connect to the internet or simply provide user interface components such as buttons and list boxes.

With the APT system, ActiveX Controls are deployed to allow direct control over (and also reflect the status of) the range of electronic controller units, including the BSC201 stepper motor controller. Software applications that use ActiveX Controls are often referred to as 'client applications'. Based on ActiveX interfacing technology, an ActiveX Control is a language independent software component. Consequently ActiveX Controls can be incorporated into a wide range of software development environments for use by client application developers. Development environments supported include Visual Basic, Labview, Visual C++, C++ Builder, HPVEE, Matlab, VB.NET, C#.NET and, via VBA, Microsoft Office applications such as Excel and Word. Consider the ActiveX Control supplied for the BSC201 APT stepper controller unit.



This Control provides a complete user graphical instrument panel to allow the motor unit to be manually operated, as well as a complete set of software functions (often called methods) to allow all parameters to be set and motor operations to be automated by a client application. The instrument panel reflects the current operating state of the controller unit to which it is associated (e.g. such as motor position). Updates to the panel take place automatically when a user (client) application is making software calls into the same Control. For example, if a client application instructs the associated stepper motor Control to move a motor, the progress of that move is reflected automatically by changing position readouts on the graphical interface, without the need for further programming intervention.



The APT ActiveX Controls collection provides a rich set of graphical user panels and programmable interfaces allowing users and client application developers to interact seamlessly with the APT hardware. Each of the APT controllers has an associated ActiveX Control and these are described fully in system online help or the handbooks associated with the controllers. Note that the APTUser and APTConfig utilities take advantage of and are built on top of the powerful functionality provided by the APT ActiveX Server (as shown in Fig. 2.2).

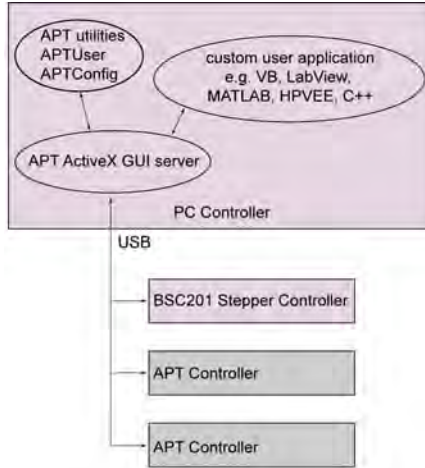

**Fig. 2.2 System Architecture Diagram**

Refer to the main APT Software online help file, APTServer.hlp, for a complete programmers guide and reference material on using the APT ActiveX Controls collection. Additional software developer support is provided by the APT Support CD supplied with every APT controller. This CD contains a complete range of tutorial samples and coding hints and tips, together with handbooks for all the APT controllers.

### 2.2.5 Software Upgrades

Thorlabs operate a policy of continuous product development and may issue software upgrades as necessary.

Detailed instructions on installing upgrades are included on the APT Software CD ROM.

---

## Chapter 3 Getting Started

### 3.1 Installing APT Software



#### Caution



If your PC becomes unresponsive (e.g due to an operating system problem, entering a sleep state condition, or screen saver operation) for a prolonged period, this may interrupt communication between the APT Software and the hardware, and a communications error may be generated. To minimize the possibility of this happening it is strongly recommended that any such modes that result in prolonged unresponsiveness be disabled before the APT software is run. Please consult your system administrator or contact Thorlabs technical support for more details.



#### Caution



Some PCs may have been configured to restrict the users ability to load software, and on these systems the software may not install/run. If you are in any doubt about your rights to install/run software, please consult your system administrator before attempting to install.

If you experience any problems when installing software, contact Thorlabs on +44 (0)1353 654440 and ask for Technical Support.

#### DO NOT CONNECT THE CONTROLLER TO YOUR PC YET

- 1) Insert the CD into your PC.
- 2) The CD should run automatically. If your CD does not start, double click the file 'autorun.exe', found on the Software CD.
- 3) A Welcome dialogue screen is displayed. Before installing the software, you are strongly advised to read the Installation Guide. Click the associated link.



- 4) Once you are familiar with the installation procedure, click the 'Install APT Software' hyperlink displayed on the Welcome dialogue screen.
- 5) Follow the on-screen instructions - see the Installation Guide supplied for more information.

## 3.2 Mechanical Installation

### 3.2.1 Siting

The BSC201 is designed to be mounted free standing on a shelf, benchtop or similar surface.



#### Caution



**When siting the unit, it should be positioned so as not to impede the operation of the rear panel power supply switch or the control panel buttons.**

**Ensure that proper airflow is maintained to the rear of the unit.**

### 3.2.2 Environmental Conditions



#### Warning



**Operation outside the following environmental limits may adversely affect operator safety.**

Location	Indoor use only
Maximum altitude	2000 m
Temperature range	5°C to 40°C
Maximum Humidity	Less than 80% RH (non-condensing) at 31°C

To ensure reliable operation the unit should not be exposed to corrosive agents or excessive moisture, heat or dust.

If the unit has been stored at a low temperature or in an environment of high humidity, it must be allowed to reach ambient conditions before being powered up.

The unit must not be used in an explosive environment.

### 3.3 Electrical Installation



#### Warning



The safety of any system incorporating this equipment is the responsibility of the person performing the installation.

#### 3.3.1 Connecting To The Supply



#### Shock Warning



The unit must be connected only to an earthed fused supply of 110 to 230V. Use only power supply cables supplied by Thorlabs, other cables may not be rated to the same current.

The unit is shipped to the UK, Europe and the USA, with the appropriate power plug already fitted. When shipped to other territories the appropriate power plug must be fitted by the user. Cable identification is as follows:

Brown-Live  
Blue-Neutral  
Green/Yellow-Earth/Ground

#### 3.3.2 Fuses

Two T 3A/250V a.c. antisurge ceramic fuses are located on the back panel, one for the live feed and one for the neutral as follows:

Fuse	Rating	Type	Fused Line
F1	T 3.15A	ceramic; antisurge	Live feed
F2	T 3.15A	ceramic; antisurge	Neutral feed

When replacing fuses:

- 1) Switch off the power and disconnect the power cord before removing the fuse cover.
- 2) Always replace broken fuses with a fuse of the same rating and type.

#### 3.3.3 Current Leakage.



#### Caution



The power supply filters may exhibit some ground loop current leakage and could trip very sensitive detection circuits.

### 3.3.4 Rear Panel Connections

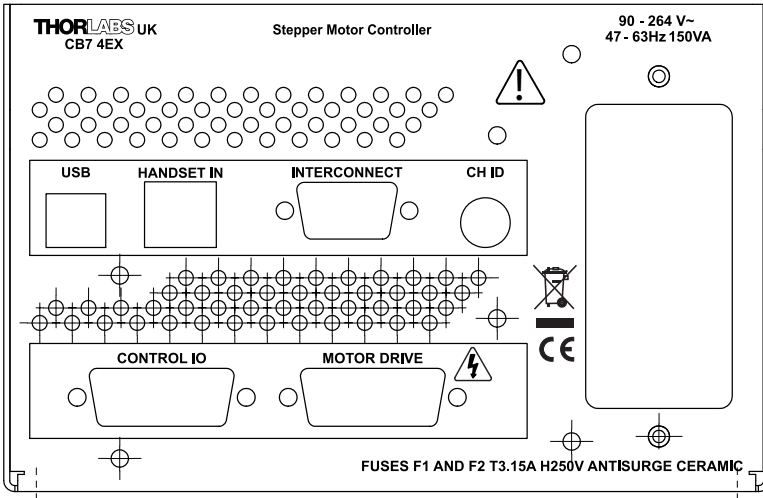

Fig. 3.1 Rear panel connections

**USB** - USB port for system communications.

#### Note

The USB cable length should be no more than 3 metres unless a powered USB hub is being used.

**HANDSET IN** - Provides connection for the MJC001 Joystick - see Section 4.10. and Section A.2.

**INTERCONNECT** - (9-Pin D-Type, Male) For Future Use.

**CH ID** - For channel selection when using the MJC001 joystick - see Section 4.10.

**MOTOR DRIVE** - (15-Pin D-Type, Female) Provides connection to the actuator.

This connector provides all phase current drive and encoder feedback connections to drive a range of encoded and non-encoded stepper motors - see Section A.3.

**CONTROL I/O** - (15-Pin D-Type, Female) The 'CONTROL I/O' connector exposes a number of electrical signals useful for external control. It is possible to configure a particular controller to respond to trigger inputs (see Section A.1.4.), generate trigger outputs (see Section A.1.3.) or both respond to and generate a trigger output - see Section 5.3.3. Motor jogging lines can be used to jog the motor in both forward and reverse directions from a remote handset (Jogging parameters (e.g. jog distance) are set via the GUI panel - see Section 5.3.1.)

### 3.4 Front Panel Controls and Indicators

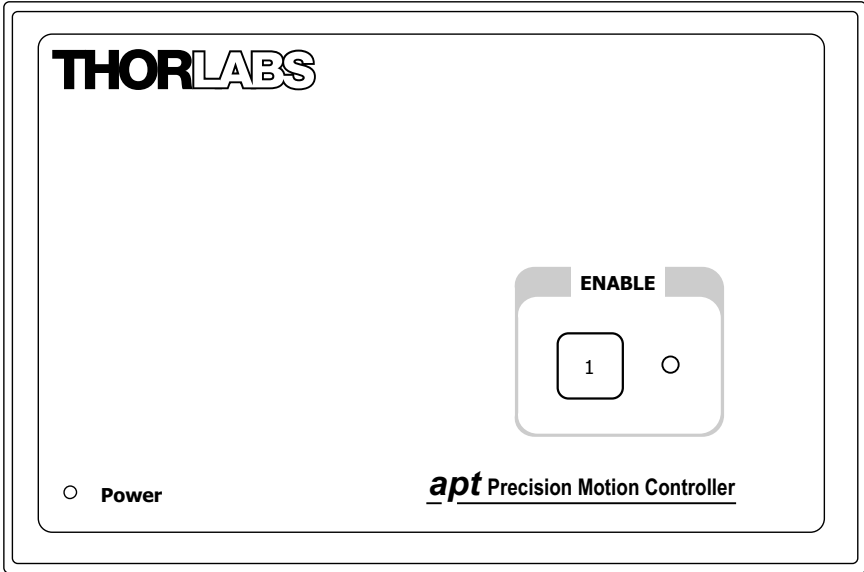

Fig. 3.2 Front panel controls and indicators

**Power LED** – Indicates that power is applied to the unit.

**Enable button** – Used to enable/disable channel functionality. The associated LED is lit when the channel is enabled. Disabling the channel allows the motor actuator to be operated manually.

### 3.5 Connecting The Hardware

- 1) Perform the mechanical installation as detailed in Section 3.2.
- 2) Install the APT Software - see Section 3.1.
- 3) Connect the stepper motor actuator to the Controller unit - see Section 3.3.4.
- 4) Connect the Controller unit to the power supply - see Section 3.3.1.
- 5) Connect the PSU to the main supply and switch 'ON'.
- 6) Connect the Controller unit to your PC.

#### Note

**The USB cable should be no more than 3 metres in length. Communication lengths in excess of 3 metres can be achieved by using a powered USB hub).**

- 7) Windows™ should detect the new hardware. Wait while Windows™ installs the drivers for the new hardware - see the Getting Started guide for more information.

### 3.6 Select the Stage Type (Using APTConfig)

To ensure that a particular stage is driven properly by the system, a number of parameters must first be set. These parameters relate to the physical characteristics of the stage being driven (e.g. min and max positions, leadscrew pitch, homing direction etc.).

To assist in setting these parameters correctly, it is possible, using the APT Config utility, to associate a specific stage type and axis with the motor controller channel. Once this association has been made, the APT server applies automatically, suitable default parameter values on boot up of the software.

#### Note

**To use the increased resolution and velocity functionality offered by these controllers, the stage types prefixed by 'HS' (e.g. HS NanoMax 300 X Axis) must be selected. Failure to select the correct stage type will result in reduced velocity and resolution.**

- 1) Shut down all applications using the APT server (e.g. APT User or your own custom application).
- 2) Run the APT Config utility - Start/All Programs/Thorlabs/APT Config/APT Config.
- 3) From the 'APT Configuration Utility' window, click the 'Stage' tab.

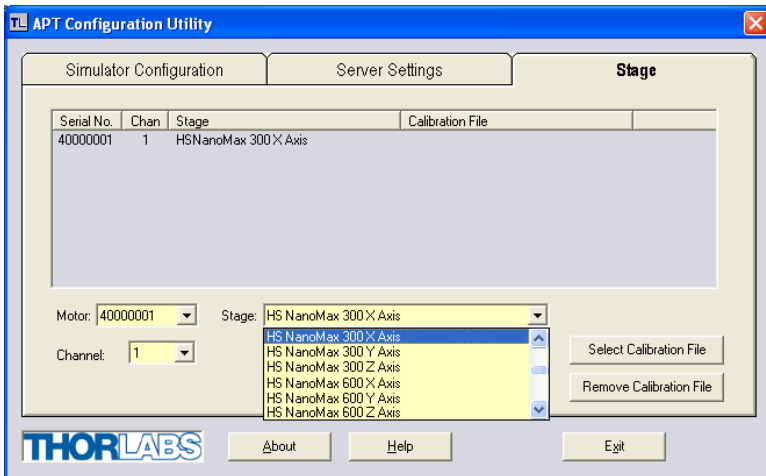

Fig. 3.3 APT Configuration Utility - Stage Tab

- 4) In the 'Motor' field, select the serial number of the stepper motor controller to be configured (this number can be found on the rear panel of the BSC201 unit).

**Note**

**To use the increased resolution and velocity functionality offered by these controllers, the stage types prefixed by 'HS' (e.g. HS NanoMax 300 X Axis) must be selected. Selecting a stage/actuator type without the 'HS' prefix will result in reduced velocity and resolution.**

- 5) In the 'Stage' field, select your actuator type from the list displayed (e.g. HS NanoMax 300 X Axis).
- 6) Click the 'Add Stage Association' button.
- 7) The server reads in the stage and controller information on start up. Shut down the APTConfig utility and proceed to Section 3.7. to verify the software operation. See the APT Config utility on line help for further information.



## 3.7 Verifying Software Operation

### 3.7.1 Initial Setup

The APT Software should be installed (Section 3.1.) and the stage association performed (Section 3.6.) before software operation can be verified.

- 1) Run the APTUser utility and check that the Graphical User Interface (GUI) panel appears and is active.

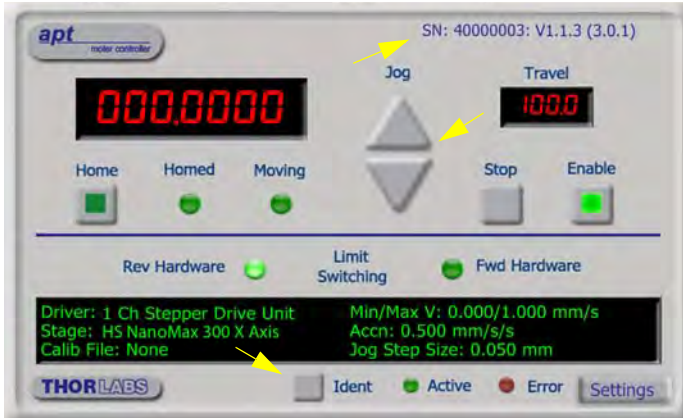

Fig. 3.4 Gui panel showing jog and ident buttons

- 2) Check that the actuator type and serial number associated in Section 3.6. are displayed in the GUI panel.
- 3) Click the 'Ident' button. The LED on the front panel of the controller flashes. This is useful in multi-channel systems for identifying which driver unit is associated with which GUI.
- 4) Click the jog buttons on the GUI panel and check that the motor or axis connected to the controller moves. The position display for the associated GUI should increment and decrement accordingly.

Follow the tutorial steps described in Chapter 4 for further verification of operation.

### Note

The 'APT Config' utility can be used to set up simulated hardware configurations and place the APT Server into simulator mode. In this way it is possible to create any number and type of simulated (virtual) hardware units in order to emulate a set of real hardware. This is a particularly useful feature, designed as an aid to application program development and testing. Any number of 'virtual' control units are combined to build a model of the real system, which can then be used to test the application software offline. If using real hardware, ensure that Simulator Mode is disabled. If using a simulated setup, enable Simulator Mode and set up a 'Simulated Configuration' - see Section 4.12. or the *APTConfig* helpfile for detailed instructions.

---

# Chapter 4 Operation - Tutorial

## 4.1 Introduction

The following brief tutorial guides the user through a typical series of moves and parameter adjustments performed using the PC based APT software. It assumes that the unit is electrically connected to the stage, and that the APT Software is already installed - see Section 3.1. For illustration purposes, it also assumes that a NanoMax300 stage is connected to the 'Motor' connector on the rear panel.

## 4.2 Using the APT User Utility

The APT User.exe application allows the user to interact with any number of APT hardware control units connected to the PC USB Bus (or simulated via the APTConfig utility). This program allows multiple graphical instrument panels to be displayed so that multiple APT units can be controlled. All basic operating parameters can be set through this program, and all basic operations (such as motor moves) can be initiated. Hardware configurations and parameter settings can be saved to a file, which simplifies system set up whenever APT User is run up.

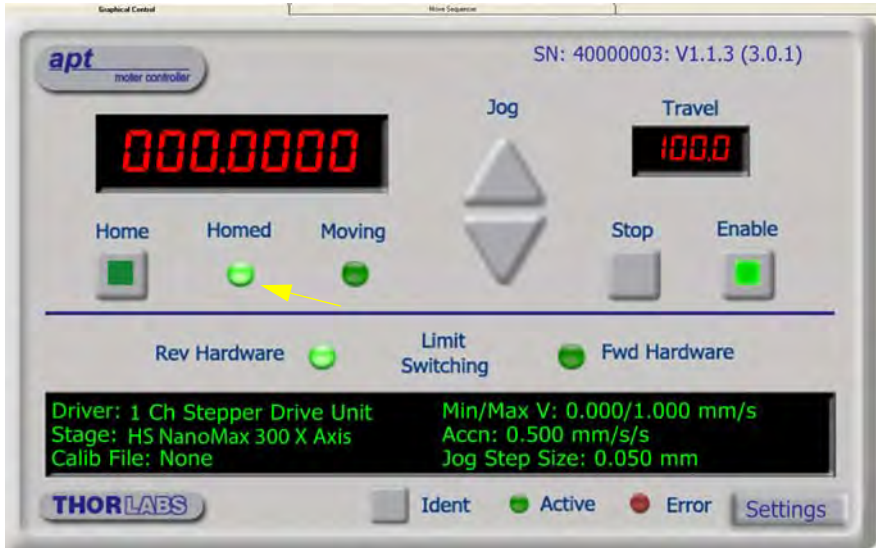

Fig. 4.1 Typical APT User Screen

- 1) Run the APT User program - Start/All Programs/Thorlabs/APT User/APT User.

### 4.3 Homing Motors

Homing the motor moves the actuator to the home limit switch and resets the internal position counter to zero. The limit switch provides a fixed datum that can be found after the system has been powered up.



**Fig. 4.2 Motor Controller Software GUI**

- 1) Click the 'Home' button. Notice that the led in the button lights to indicate that homing is in progress and the displayed position for both channels counts down to 000.000, i.e the home position.
  - 2) When homing is complete, the 'Homed' LED is lit as shown above.
- See Appendix F , Section F.2.2. for background information on the home position.

## 4.4 Moving to an Absolute Position

Absolute moves are measured in real world units (e.g. millimetres), relative to the Home position.

- 1) Click the position display.

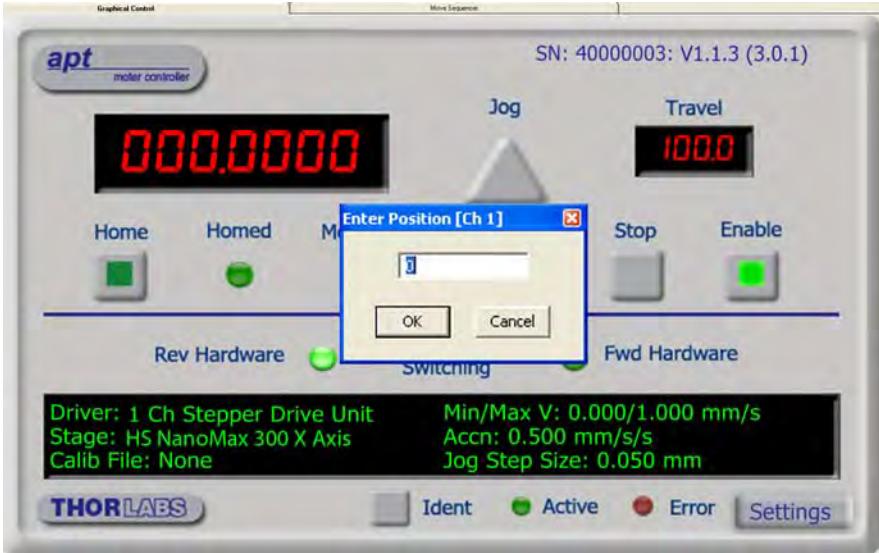

Fig. 4.3 Absolute Position Popup Window

- 2) Enter 3.0 into the pop up window
- 3) Click 'OK'. Notice that the position display counts up to 003.000 to indicate a move to the absolute position 3.00mm.

## 4.5 Stopping the Stage

The drive channel is enabled and disabled by clicking the 'Enable' button on the GUI panel or the front panel of the unit. The green indicator is lit when the drive channel is enabled. Disabling the channel removes the drive power and allows the stage/actuator to be positioned manually.

During operation, the stage can be stopped at any time by clicking the 'Stop' button on the GUI panel. Using this button does not remove power to the drive channel.

## 4.6 Changing Motor Parameters

### Note

Moves are performed using a Trapezoidal or S-Curve velocity profile (see Appendix F, Section F.1.3.). The velocity settings relate to the maximum velocity at which a move is performed, and the acceleration at which the motor speeds up from zero to maximum velocity.

- 1) On the GUI panel, click the 'Settings' button (bottom right hand corner of the display) to display the Settings panel.

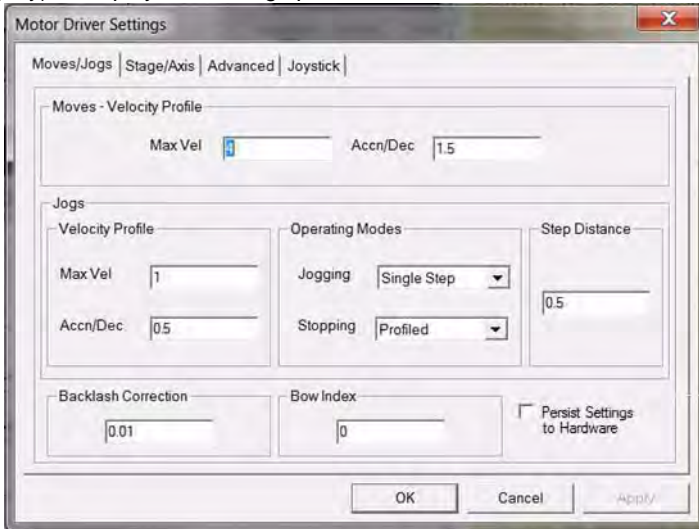

Fig. 4.4 Settings Panel - Move/Jogs Tab

- 2) Select the Move/Jogs tab as shown in Fig. 4.4.
- 3) In the 'Moves' field, change the parameters as follows:  
'Max. Vel' - '4'  
'Accn/Dec' - '1.5'

### Note

In current versions of software, the 'Min Vel' parameter is locked at zero and cannot be adjusted.

- 4) Click 'OK' to save the settings and close the window.
- 5) Any further moves initiated on channel 1 will now be performed at a maximum velocity of 4 mm per second, with an acceleration of 1.5 mm/sec/sec.

See Section 5.3.1. for more information on these parameters.

## 4.7 Jogging

During PC operation, the motor actuators are jogged using the GUI panel arrow keys. There are two jogging modes available, 'Single Step' and 'Continuous'. In 'Single Step' mode, the motor moves by the step size specified in the Step Distance parameter. If the jog key is held down, single step jogging is repeated until the button is released - see Fig. 4.5. In 'Continuous' mode, the motor actuator will accelerate and move at the jog velocity while the button is held down.

- 1) On the GUI panel, click the 'Settings' button to display the Settings panel.



Fig. 4.5 Settings Panel - Move/Jogs Tab

- 2) Select the Move/Jogs tab as shown in Fig. 4.5.
- 3) In the 'Jogs' field, enter parameters as follows:  
 'Max. Vel' - '1'  
 'Accn/Dec' - '0.5'

### Note

**In current versions of software, the 'Min Vel' parameter is locked at zero and cannot be adjusted.**

'Jogging' - 'Single Step'  
 'Stopping' - 'Profiled'  
 'Step Distance' - '0.5'

- 4) Click 'OK' to save the settings and close the window.
- 5) Click the Jog Arrows on the GUI panel to jog the motor. Notice that the position display increments 0.5 every time the button is clicked.

## 4.8 Graphical Control Of Motor Positions (Point and Move)

The GUI panel display can be changed to a graphical display, showing the position of the motor channel(s). Moves to absolute positions can then be initiated by positioning the mouse within the display and clicking.

To change the panel view to graphical view, right click in the screen and select 'Graphical View'.



Fig. 4.6 Motor GUI Panel - Graphical View

Consider the display shown above for a BSC201 Stepper Motor Controller.

The right hand display shows the channel and motor unit parameters; i.e. controller unit type and serial number, associated stage and actuator type, minimum and maximum positions, current position, units per grid division and cursor position. All units are displayed in real world units, either millimetres or degrees.

### Note

**For single channel units such as the BSC201, the Channel 2 parameters are greyed out.**

The left hand display shows a circle, which represents the current position of the motor associated with the specified controller (absolute position data is displayed in the 'Chan Pos' field).

The vertical divisions relate to the travel of the stage/actuator associated with the controller (the stage/actuator is selected in the 'APT Config' utility). For example, the screen shot above shows the parameters for a 4 mm travel NanoMax 3-axis stage. The graph shows 8 divisions in the X axis, which relates to 0.5 mm of travel per division (4.0 mm in total).

The graphical panel has two modes of operation, 'Jog' and 'Move', which are selected by clicking the buttons at the bottom right of the screen.

### **Move Mode**

When 'Move' is selected, the motors move to an absolute position which corresponds to the position of the cursor within the screen.

To specify a move:

- 1) Position the mouse within the window. For reference, the absolute motor position values associated with the mouse position is displayed in the 'Cursor Position' field.
- 2) Click the left hand mouse button to initiate the move.

### **Jog Mode**

When 'Jogging' mode is selected, the motors are jogged each time the left mouse button is clicked.

The Jog direction corresponds to the position of the cursor relative to the circle (current motor position), e.g. if the cursor is to the left of the circle the motor will jog left. The Jog Step size is that selected in the Settings panel - see Section 5.3.

### **Stop**

To stop the move at any time, click the 'Stop' button.

### **Returning to Panel View**

To return to panel view, right click in the graphical panel and select 'Panel View'.



## 4.9 Setting Move Sequences

This section explains how to set move sequences, allowing several positions to be visited without user intervention.

For details on moving to absolute positions initiated by a mouse click – see Section 4.12.

- 1) From the Motor GUI Panel, select 'Move Sequencer' tab to display the Move Sequencer window.

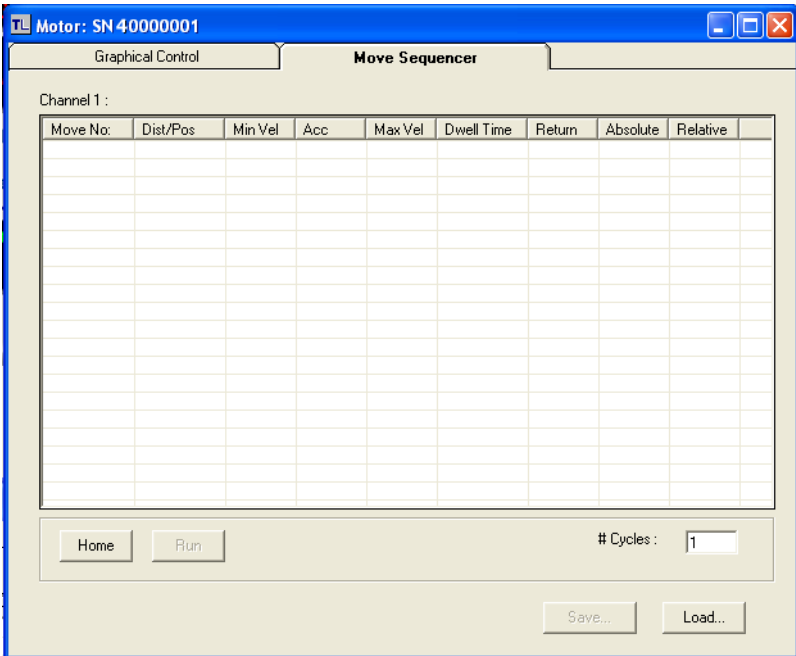

**Fig. 4.7 Move Sequencer Window**

- 2) Right click, in the move data field to display the pop up menu.

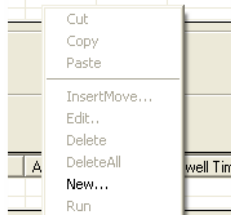

**Fig. 4.8 Move Sequencer Pop Up Menu**

3) Select 'New' to display the 'Move Editor' panel.

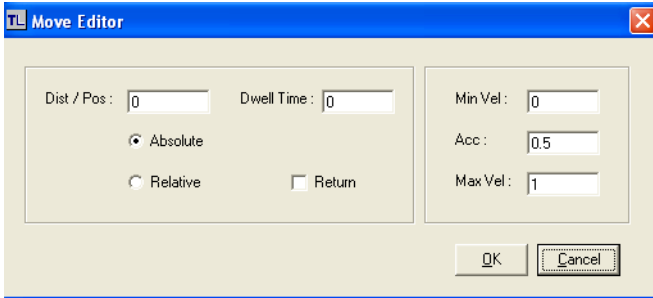

Fig. 4.9 Move Editor Window

Move data is entered/displayed as follows:

**Dist/Pos:** - the distance to move from the current position (if 'Relative' is selected) or the position to move to (if 'Absolute' is selected).

**Dwell Time:** - after the move is performed, the system can be set to wait for a specified time before performing the next move in the sequence. The Dwell time is the time to wait (in milliseconds).

**Return** - if checked, the system will move to the position specified in the Dist/Pos field, wait for the specified Dwell time, and then return to the original position.

**Min Vel: Acc: and Max Vel:** - the velocity profile parameters for the move.

**Note**

**In current versions of software, the 'Min Vel' parameter is locked at zero and cannot be adjusted.**

The motor accelerates at the rate set in the Acc field up to the speed set in the Max Vel field. As the destination approaches, the motor decelerates again to ensure that there is no overshoot of the position.

- 4) Enter the required move data into the Move Editor and click OK. The move data is displayed in the main window as shown below.

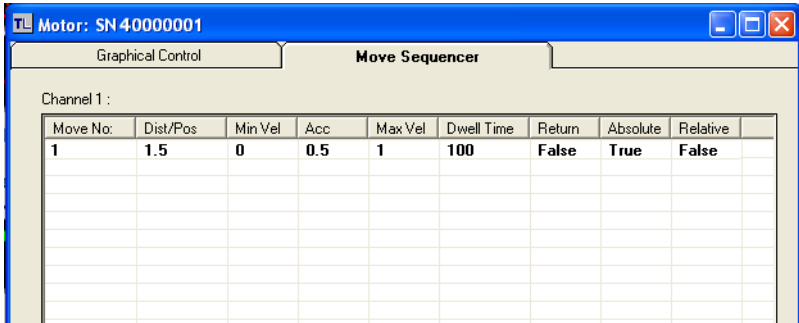

**Fig. 4.10 Main Window with Move Data**

- 5) Repeat step 4 as necessary to build a sequence of moves. Move data can be copied, deleted, cut/pasted and edited by right clicking the data line(s) and selecting the appropriate option in the pop up menu (shown below).

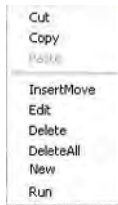

**Fig. 4.11 Pop Up Options**

- 6) To run a single line of data, right click the appropriate data and select 'Run' from the pop up menu (shown above).
- 7) To run the entire sequence, click the 'Run' button (shown below). A Home move can also be performed from this panel by clicking the 'Home' button.

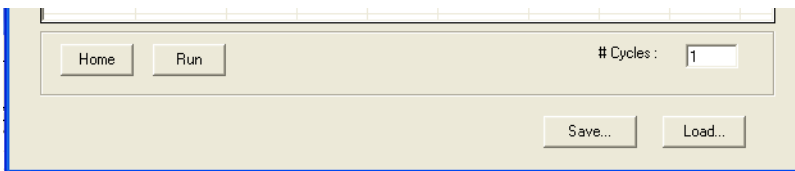

**Fig. 4.12 Home and Run Buttons**

- 8) To save data to a file, or load data from a previously saved file, click the 'Save' or 'Load' button and browse to the required location.

## 4.10 Using A Joystick Console

The MJC001 joystick console has been designed to provide intuitive, tactile, manual positioning of the stage. The console features a two axis joystick for XY control. Up to 3 joysticks can be connected to each other, interfacing neatly into a multi-channel control application.

### Note

**The default parameter values loaded at the factory should be acceptable for most applications, and in this case, it is not necessary to connect the controller to a PC running the APT software. If these parameter values subsequently require adjustment, this can only be performed by running the APT software - see Section 5.3.4. for more information.**

### Note

**In order for the controller and joystick to be used without a host PC, the Move/Jog settings, Stage/Axis settings and the Joystick settings must be persisted (saved) within the BSC201 unit before the following procedure is performed. This is done by checking the 'Persist Settings' box on each settings tab - see Section 5.3. for more details.**

- 1) Connect the stage to the Controller unit.
- 2) Connect the joystick console to the HANDSET IN connector of the controller.
- 3) Switch ON the controller.
- 4) Wait until the red led on the joystick console and the Channel Enable LED on the controller front panel stops flashing (~3s).  
Press and hold the 'High/Low' button for 2 seconds to home the stage. When homing is complete, the green LED stops flashing.

In order to establish control over a particular axis, the joystick axes must be associated with the corresponding channels of the related controller. This is achieved by setting the joystick ID switch, located on the underside of the joystick console, and the channel ident switches on the rear panel of the BSC controller.

The joystick ID switch assigns the selected number to the X axis of the joystick and the next sequential number to the Y axis. The channel ident switches on the controller unit(s) must then be set to match these joystick axis numbers.

For example, if the joystick switch is set to '1', then the channel ID switch on the controller must also be set to '1' as shown in Fig. 4.1. If two single channels are being used, the Y-Axis controller unit must be set to '2'.

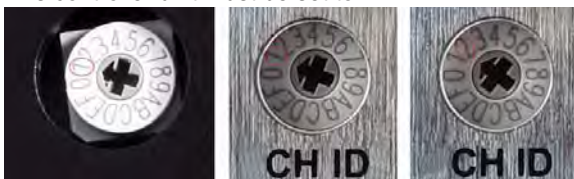

Fig. 4.1 ID switch settings

- 5) Set the joystick console ID switch and the controller channel ID switches as described in the preceding paragraph.



### Caution



**Do not set the switches to identical numbers as this may result in lack of joystick control. Also, do not set the channel ID switches to 'E' or 'F' as this is reserved for factory use and testing.**

- 6) Open the APTConfig utility and ensure that the appropriate 'HS' option is selected for the actuator being driven (e.g. HS 17DRV013). If an option without the HS prefix is selected, then the joystick will not function - see Section 3.6.
- 7) The stage can now be moved using the joystick, GUI panel, or by setting commands to move each axis by relative and absolute amounts – see the helpfile supplied with the APT server for more information.

## 4.11 External Triggering

External triggering is facilitated by the Trigger In and Trigger Out pins (pins 4 and 12) of the CONTROL IO connector on the rear panel of the unit.

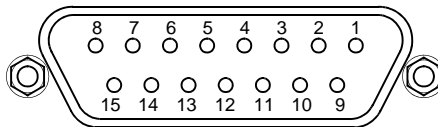

These connectors provide a 5V logic level input and output that can be configured to support triggering from and to external devices - see Section 5.3.3. and Section A.1.3. for further details.

## 4.12 Creating a Simulated Configuration Using APT Config

The 'APT Config' utility can be used to set up simulated hardware configurations and place the APT Server into simulator mode. In this way it is possible to create any number and type of simulated (virtual) hardware units in order to emulate a set of real hardware. This is a particularly useful feature, designed as an aid learning how to use the APT software and as an aid to developing custom software applications 'offline'.

Any number of 'virtual' control units can be combined to emulate a collection of physical hardware units. For example, an application program can be written, then tested and debugged remotely, before running with the hardware.

To create a simulated configuration proceed as follows:

- 1) Run the APT Config utility - Start/All Programs/Thorlabs/APT/APT Config.

- 2) Click the 'Simulator Configuration' tab.

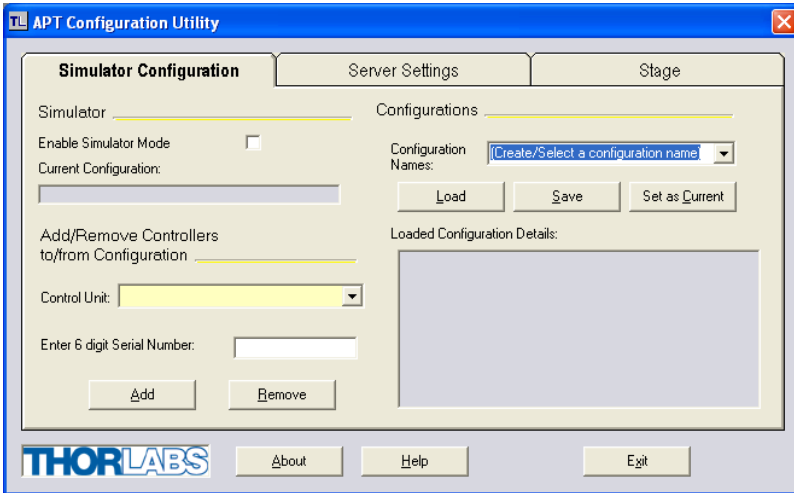
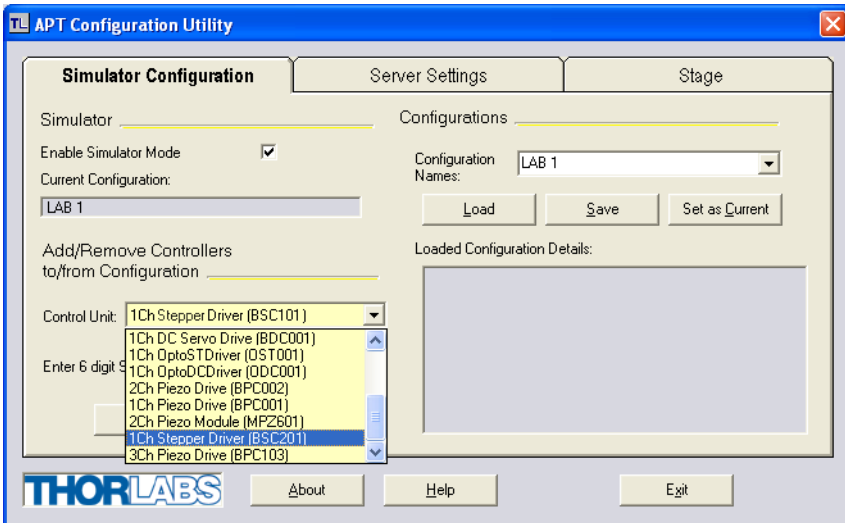
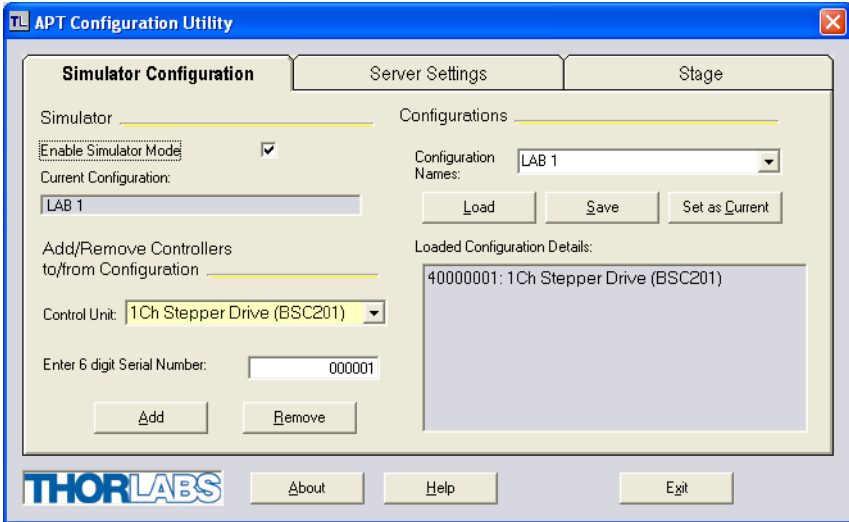

Fig. 4.13 APT Configuration Utility - Simulator Configuration Tab

- 3) Enter 'LAB1' in the Configuration Names field.
- 4) In the 'Simulator' field, check the 'Enable Simulator Mode' box. The name of the most recently used configuration file is displayed in the 'Current Configuration' window.



- 5) In the 'Control Unit' field, select '1 Ch Stepper Driver (BSC201)'.



- 6) Enter a 6 digit serial number.

### Note

Each physical APT hardware unit is factory programmed with a unique 8 digit serial number. In order to simulate a set of 'real' hardware the Config utility allows an 8 digit serial number to be associated with each simulated unit. It is good practice when creating simulated configurations for software development purposes to use the same serial numbers as any real hardware units that will be used. Although serial numbers are 8 digits (as displayed in the 'Load Configuration Details' window, the first two digits are added automatically and identify the type of control unit.

The prefixed digits relating to the BSC201 stepper controller are:  
**40xxxxxx - Benchtop APT Single Channel Stepper Motor Controller**

- 7) Click the 'Add' button.
- 8) Repeat items (1) to (7) as required. (A unit can be removed from the configuration by selecting it in the 'Loaded Configuration Details' window and clicking the 'Remove' button or by right clicking it and selecting the 'Remove' option from the pop up window).
- 9) Enter a name into the 'Configuration Names' field.
- 10) Click 'Save'.
- 11) Click 'Set As Current' to use the configuration.

### 4.13 Stage/Axis Tab

This tab contains a number of parameters which are related to the physical characteristics of the particular stage or actuator being driven. They need to be set accordingly such that a particular stage is driven properly by the system.

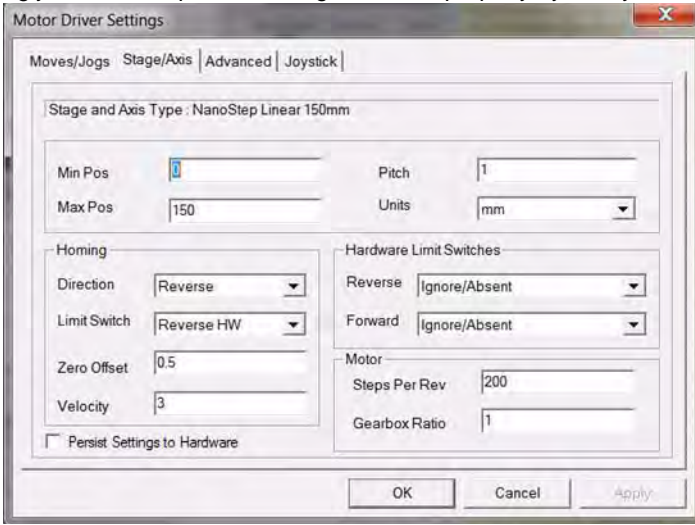

Fig. 4.14 Stage/Axis Tab

These parameters were set automatically when the DRV113 actuator was selected using the APTConfig utility in Section 3.6. The APT server automatically applied suitable defaults for the parameters on this tab during boot up of any client software such as APTUser. These parameters should not be altered for pre-defined Thorlabs stages and actuators selected using APT Config, as it may adversely affect the performance of the stage.

For custom stage types not available using the APT Config utility, the stage details must be entered manually.

Individual parameters are described in Section 5.3.



---

# Chapter 5 Software Reference

## 5.1 Introduction

This chapter gives an explanation of the parameters and settings accessed from the APT software running on a PC. For information on the methods and properties which can be called via a programming interface, see Appendix E .

## 5.2 GUI Panel

The following screen shot shows the graphical user interface (GUI) displayed when accessing the stepper controller using the APTUser utility.



Fig. 5.1 Motor Controller Software GUI

---

### Note

The serial number of the BSC201 controller associated with the GUI panel, the APT server version number, and the version number (in brackets) of the embedded software running on the unit, are displayed in the top right hand corner. This information should always be provided when requesting customer support.

**Jog** - used to increment or decrement the motor position. When the button is clicked, the motor is driven in the selected direction at the jog velocity one step per click. The step size and jog velocity parameters are set in the 'Settings' panel (see Section 5.3.).

**Travel** - displays the range of travel (in millimeters or degrees) of the motor.

**Moving** - lit when the motor is in motion.

**Enable** - applies power to the motor. With the motor enabled, the associated Channel LED on the front panel is lit.

**Digital display** - shows the position (in millimetres or degrees) of the motor. The motor must be 'Homed' before the display will show a valid position value, (i.e. the displayed position is relative to a physical datum, the limit switch).

**Home** - sends the motor to its 'Home' position - see Appendix F Section F.2.2. The LED in the button is lit while the motor is homing.

**Homed** - lit when the motor has previously been 'Homed' (since power up).

**Stop** - halts the movement of the motor.

**Limit switches** - the LEDs are lit when the associated limit switch has been activated - see Appendix F Section F.2.3. for further details on limit switches.

**Settings display** - shows the following user specified settings:

*Driver* - the type of control unit associated with the specified channel.

*Stage* - the stage type and axis associated with the specified channel.

*Calib File* - the calibration file associated with the specified channel.

See the APTConfig utility helpfile for more details on assigning and using calibration files.

*Min/Max V* - the minimum velocity at which a move is initiated, and the maximum velocity at which the move is performed. Values are displayed in real world units (mm/s or degrees/s), and can be set via the 'Settings' panel (see Section 5.3.).

*Accn* - the rate at which the velocity climbs to, and slows from, maximum velocity, displayed in real world units (mm/s/s or degrees/s/s). The acceleration can be set via the 'Settings' panel (see Section 5.3.) and is used in conjunction with the Min/Max velocity settings to determine the velocity profile of a motor move. See Appendix F Section F.1.3. for more information on velocity profiles.

*Jog Step Size* - the size of step (in mm or degrees) taken when the jog signal is initiated. The step size can be set either via the Settings panel or by calling the SetJogStepSize method.

**Settings button** - Displays the 'Settings' panel, which allows the motor drive's operating parameters to be entered - see Section 5.3.

**Ident** - when this button is pressed, the LED (on the front panel of the unit) associated with the selected channel will flash for a short period.

**Active** - lit when the unit is operating normally and no error condition exists.

**Error** - lit when a fault condition occurs.

## 5.3 Settings Panel

When the 'Settings' button on the GUI panel is clicked, the 'Settings' window is displayed. This panel allows motor operation parameters such as move/jog velocities, and stage/axis information to be modified. Note that all of these parameters have programmable equivalents accessible through the ActiveX methods and properties on this Control (refer to the *Programming Guide* in the *APTServer helpfile* for further details and to Section 2.2.4. for an overview of the APT ActiveX controls).

### 5.3.1 Moves/Jogs tab

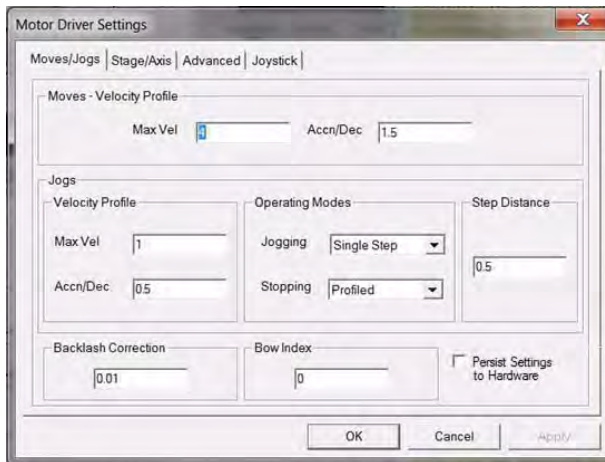

Fig. 5.2 Stepper Motor Controller - Move/Jog Settings

### Moves

Moves can be initiated via the GUI panel by entering a position value after clicking on the position display box (see Section 4.4.) or by calling a software function (see the APTServer helpfile). The following settings determine the velocity profile of such moves, and are specified in real world units, millimetres or degrees.

*Velocity Profile* (specified in real world units, millimetres or degrees).

*MaxVel* - the maximum velocity at which to perform a move.

*Accn/Dec* - the rate at which the velocity climbs from zero to maximum, and slows from maximum to zero.

### Notes

**Under certain velocity parameter and move distance conditions, the maximum velocity may never be reached (i.e. the move comprises an acceleration and deceleration phase only).**

## Jogs

Jogs are initiated by using the 'Jog' keys on the GUI panel (see Section 4.7.), or via a jog handset connected to the Input logic pins exposed on the rear panel Control IO connector (see Appendix A ).

*Velocity Profile* (specified in real world units, millimetres or degrees)

*MaxVel* - the maximum velocity at which to perform a jog

*Accn/Dec* - the rate at which the velocity climbs from minimum to maximum, and slows from maximum to minimum.

*Note.* The 'Minimum Velocity' is locked at zero and cannot be adjusted.

### Operating Modes

*Jogging* - The way in which the motor moves when a jog command is received (i.e. handset button pressed or GUI panel button clicked).

There are two jogging modes available, 'Single Step' and 'Continuous'. In 'Single Step' mode, the motor moves by the step size specified in the Step Distance parameter. If the jog key is held down, single step jogging is repeated until the button is released - see Fig. 5.3. In 'Continuous' mode, the motor actuator will accelerate and move at the jog velocity while the button is held down..

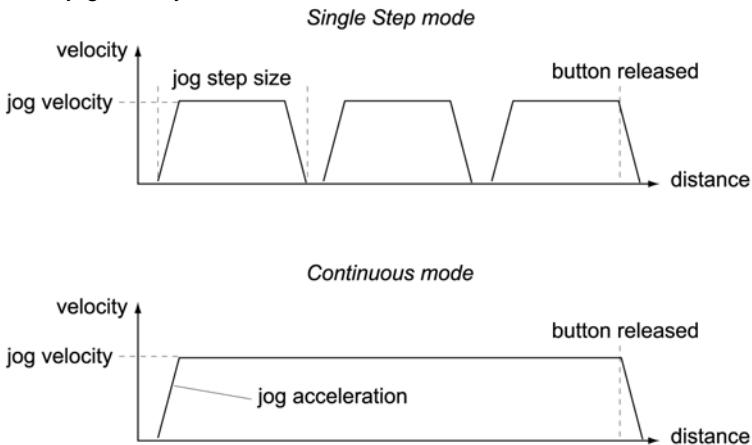

**Fig. 5.3 Jog Modes**

*Single Step* - the motor moves by the step size specified in the Step Distance parameter.

*Continuous* - the motor continues to move until the jog signal is removed (i.e. jog button is released).

*Stopping* - the way in which the jog motion stops when the demand is removed.

*Immediate* - the motor stops quickly, in a non-profiled manner

*Profiled* - the motor stops in a profiled manner using the jog Velocity Profile parameters set above.

**Step Distance** - The distance to move when a jog command is initiated. The step size is specified in real world units (mm or degrees dependent upon the stage).

**Backlash Correction** - The system compensates for lead screw backlash during reverse direction moves, by moving passed the demanded position by a specified amount, and then reversing. This ensures that positions are always approached in a forward direction. The Backlash Correction Distance is specified in real world units (millimeters or degrees). To remove backlash correction, this value should be set to zero.

### Note

**Backlash correction is not implemented during a Jog move.**

## Position Profiling

To prevent the motor from stalling, it must be ramped up gradually to its maximum velocity. Certain limits to velocity and acceleration result from the torque and speed limits of the motor, and the inertia and friction of the parts it drives.

The system incorporates a trajectory generator, which performs calculations to determine the instantaneous position, velocity and acceleration of each axis at any given moment. During a motion profile, these values will change continuously. Once the move is complete, these parameters will then remain unchanged until the next move begins.

The specific move profile created by the system depends on several factors, such as the profile mode and profile parameters presently selected, and other conditions such as whether a motion stop has been requested.

**Bow Index** – This field is used to set the profile mode to either Trapezoidal or S-curve. A *Bow Index* of '0' selects a trapezoidal profile. An index value of '1' to '18' selects an S-curve profile. In either case, the velocity and acceleration of the profile are specified using the *Velocity Profile* parameters on the *Moves/Jogs tab*.

The *Trapezoidal* profile is a standard, symmetrical acceleration/deceleration motion curve, in which the start velocity is always zero. This profile is selected when the *Bow Index* field is set to '0'.

In a typical trapezoidal velocity profile, (see Fig. 5.4.), the stage is ramped at acceleration ' $a$ ' to a maximum velocity ' $v$ '. As the destination is approached, the stage is decelerated at ' $a$ ' so that the final position is approached slowly in a controlled manner.

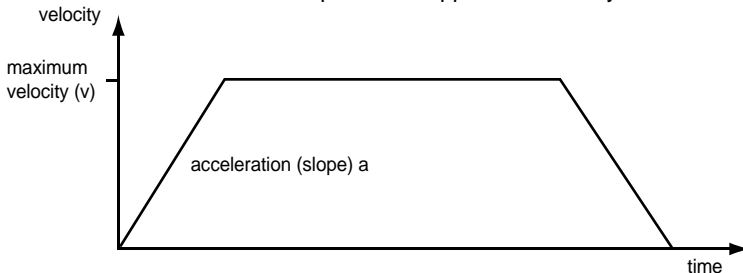

**Fig. 5.4 Graph of a trapezoidal velocity profile**

The S-curve profile is a trapezoidal curve with an additional 'Bow Value' parameter, which limits the rate of change of acceleration and smooths out the contours of the motion profile. The *Bow Value* is applied in mm/s<sup>3</sup> and is derived from the Bow Index field as follows:

Bow Value = 2 (Bow Index -1) within the range 1 to 262144 (Bow Index 1 to 18).

In this profile mode, the acceleration increases gradually from 0 to the specified acceleration value, then decreases at the same rate until it reaches 0 again at the specified velocity. The same sequence in reverse brings the axis to a stop at the programmed destination position.

Example

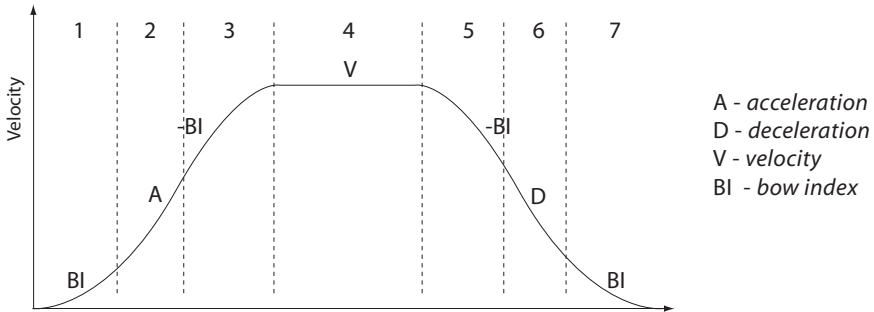

Fig. 5.5 Typical S-Curve Profile

The figure above shows a typical S-curve profile. In segment (1), the S-curve profile drives the axis at the specified Bow Index (BI) until the maximum acceleration (A) is reached. The axis continues to accelerate linearly (Bow Index = 0) through segment (2). The profile then applies the negative value of Bow Index to reduce the acceleration to 0 during segment (3). The axis is now at the maximum velocity (V), at which it continues through segment (4). The profile then decelerates in a similar manner to the acceleration phase, using the Bow Index to reach the maximum deceleration (D) and then bring the axis to a stop at the destination.

**Note**

**The higher the Bow Index, then the shorter the BI phases of the curve, and the steeper the acceleration and deceleration phases. High values of Bow Index may cause a move to overshoot.**

*Persist Settings to Hardware* - Many of the parameters that can be set for the BSC201 series drivers can be stored (persisted) within the unit itself, such that when the unit is next powered up these settings are applied automatically. This is particularly important when the driver is being used manually via a joystick, in the absence of a PC and USB link. The *Move and Jog* parameters described previously are good examples of settings that can be altered and then persisted in the driver for later use.

To save the settings to hardware, check the 'Persist Settings to Hardware' checkbox before clicking the 'OK button.

### 5.3.2 Stage/Axis tab

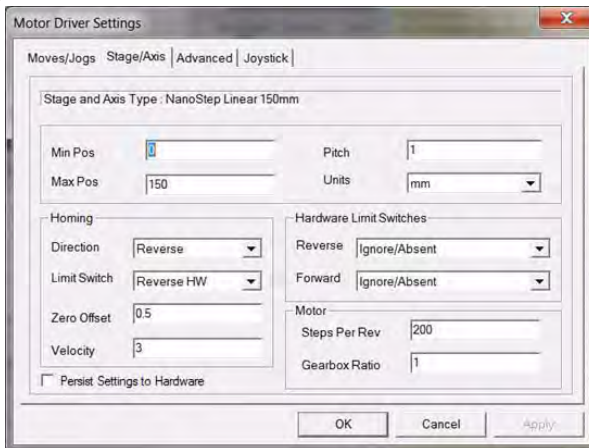

Fig. 5.6 Stepper Motor Controller - Stage/Axis Settings

#### Note

This tab contains a number of parameters which are related to the physical characteristics of the particular stage being driven. They need to be set accordingly such that a particular stage is driven properly by the system.

For Thorlabs stages, the APT Config utility can be used to associate a specific stage and axis type with the motor channel (refer to the APT Config helpfile for further details on how to associate a stage and axis). Once this association has been made, the APT server will automatically apply suitable defaults for the parameters on this tab during boot up of the software. These parameters should not be altered for pre-defined Thorlabs stages selected using APT Config, as it may adversely affect the performance of the stage.

For custom stage types not available using the APT Config utility, the stage details must be entered manually. Individual parameters are described in the following paragraphs.

*Stage and Axis Type* - For Thorlabs stages, the stage type is displayed automatically once the axis has been associated using the APTConfig utility. For third party stages, the display shows '*Unknown*'.



**Caution**



**Extreme care must be taken when modifying the stage related settings that follow. Some settings are self consistent with respect to each other, and illegal combinations of settings can result in incorrect operation of the physical motor/stage combination being driven. Consult Thorlabs for advice on settings for stage/actuator types that are not selectable via the APTConfig utility.**

*Min Pos* - the stage/actuator minimum position (typically zero).

*Max Pos* - the stage/actuator maximum position.

*Pitch* - the pitch of the motor lead screw (i.e. the distance (in millimetres or degrees) travelled per revolution of the leadscrew).

*Units* - the 'real world' positioning units (mm or degrees).

### *Homing*

When homing, a stage typically moves in the reverse direction, (i.e. towards the reverse limit switch). The following settings allow support for stages with both Forward and Reverse limits.

**Note**

**Typically, the following two parameters are set the same, i.e. both Forward or both Reverse.**

*Direction* - the direction sense to move when homing, either *Forward* or *Reverse*.

*Limit Switch* - The hardware limit switch associated with the home position, either *Forward HW* or *Reverse HW*.

*Zero Offset* - the distance offset (in mm or degrees) from the limit switch to the Home position.

*Velocity* - the maximum velocity at which the motors move when Homing.

For further information on the home position, see Section F.2.2.

### *Hardware Limit Switches*

**Note**

**The minimum velocity and acceleration/deceleration parameters for a home move are taken from the existing move velocity profile parameters.**

The operation of the limit switches is inherent in the design of the associated stage or actuator. The following parameters notify the system to the action of the switches



when contact is made. Select Rev Switch or Fwd Switch as required, then select the relevant operation.

*Switch Makes* - The switch closes on contact

*Switch Breaks* - The switch opens on contact

*Ignore/Absent* - The switch is missing, or should be ignored.

#### *Motor*

These parameters are used to set the 'resolution' characteristics of the stepper motor connected to the selected channel. The resolution of the motor, combined with other characteristics (such as lead screw pitch) of the associated actuator or stage, determines the overall resolution.

*Steps Per Rev* - The number of full steps per revolution of the stepper motor (minimum '1', maximum '10000').

#### **Note**

**The *Gearbox Ratio* parameter is applicable only to motors fitted with a gearbox.**

*Gearbox Ratio* - The ratio of the gearbox. For example, if the gearbox has a reduction ratio of X:1 (i.e. every 1 turn at the output of the gearbox requires X turns of the motor shaft) then the Gearbox Ratio value is set to X. (minimum '1', maximum '1000').

#### **Note**

**The 'Steps Per Rev' and 'Gearbox Ratio' parameters, together with the 'Pitch' and 'Units' parameters are used to calculate the calibration factor for use when converting real world units to microsteps. However, the 'Steps Per Rev' parameter is entered as full steps, not microsteps. The system automatically applies a factor of 128 microsteps per full step.**

**The stepper motors used on the majority of Thorlabs stages/actuators have 200 full steps per rev and no gearbox fitted. For these motors the Steps Per Rev and Gearbox Ratio parameters have values of 200 and 1 respectively.**

**The correct default values for Steps Per Rev and Gearbox Ratio are applied automatically when the APTConfig.exe utility is used to associate a specific stage or actuator type with a motor channel. See the APTConfig helpfile and the tutorial Section 3.6. for more details.**

*Persist Settings to Hardware* - Many of the parameters that can be set for the BSC201 series drivers can be stored (persisted) within the unit itself, such that when the unit is next powered up these settings are applied automatically. This is particularly important when the driver is being used manually via a joystick, in the absence of a PC and USB link. The *Min Pos*, *Max Pos*, and *Velocity* parameters described previously are good examples of settings that can be altered and then persisted in the driver for later use.

To save the settings to hardware, check the 'Persist Settings to Hardware' checkbox before clicking the 'OK' button.

### 5.3.3 Advanced Tab

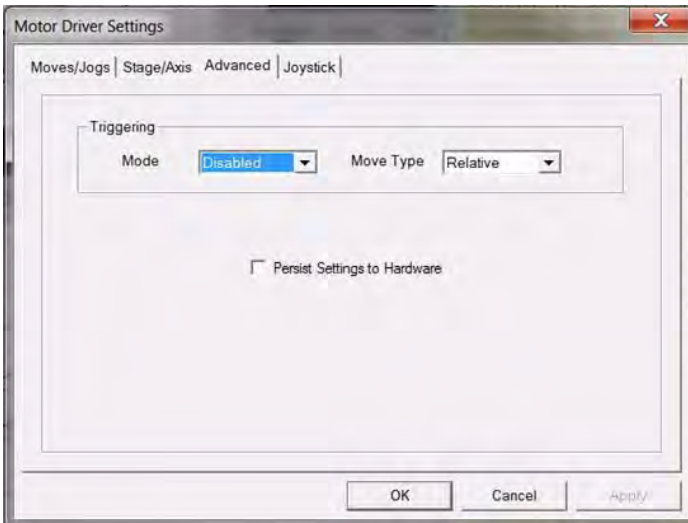

Fig. 5.7 Advanced Settings

### Triggering

#### Note

**The move parameters for triggered moves can only be set via software method calls in APTServer. Triggered moves cannot be set up via the GUI panel.**

It is possible to configure a particular controller to respond to trigger inputs, generate trigger outputs or both respond to and generate a trigger output. When a trigger input is received, the unit can be set to initiate a move (relative, absolute or home). Similarly the unit can be set to generate a trigger output signal when instructed to move via a software (USB) command. For those units configured for both input and output triggering, a move can be initiated via a trigger input while at the same time, a trigger output can be generated to initiate a move on another unit.

The trigger settings can be used to configure multiple units in a master - slave set up, thereby allowing multiple channels of motion to be synchronized. Multiple moves can then be initiated via a single software or hardware trigger command.

### *Mode*

The *Mode* parameter sets the trigger mode for the associated channel.

*Disabled* - triggering operation is disabled

*Trig In* - a move (specified using the *Move Type* parameter below) is initiated on the specified channel when a trigger input signal (i.e. rising edge) is received on the Trigger In pin (pin 4) of the rear panel CONTROL IO D-type connector - see Section A.1. for pin out details.

*Trig In/Out* - As for Trig In, but now a trigger output signal will also be generated on the Trigger Output pin (pin 12) when the move begins - see Section A.1. for pin out details.

*Trig Out* - A trigger output signal is generated on the Trigger Out pin (pin 12) when a move (relative, absolute or home) is initiated via software (either through the GUI panel or ActiveX method call).

### *Move Type*

The *Move Type* parameter determines the type of move to be initiated on the associated channel when a trigger input signal is detected on the Trig In or Trig Out connector.

*Relative* - triggered relative move. Relative move distance and velocity profile parameters can be set prior to triggering using the *SetRelMoveDist* and *SetVelParams* methods respectively.

*Absolute* - triggered absolute move. Absolute move position and velocity profile parameters can be set prior to triggering using the *SetAbsMovePos* and *SetVelParams* methods respectively.

*Home* - triggered home sequence. Homing parameters can be set prior to triggering using the *SetHomeParams* method.

For example, consider the following diagram:

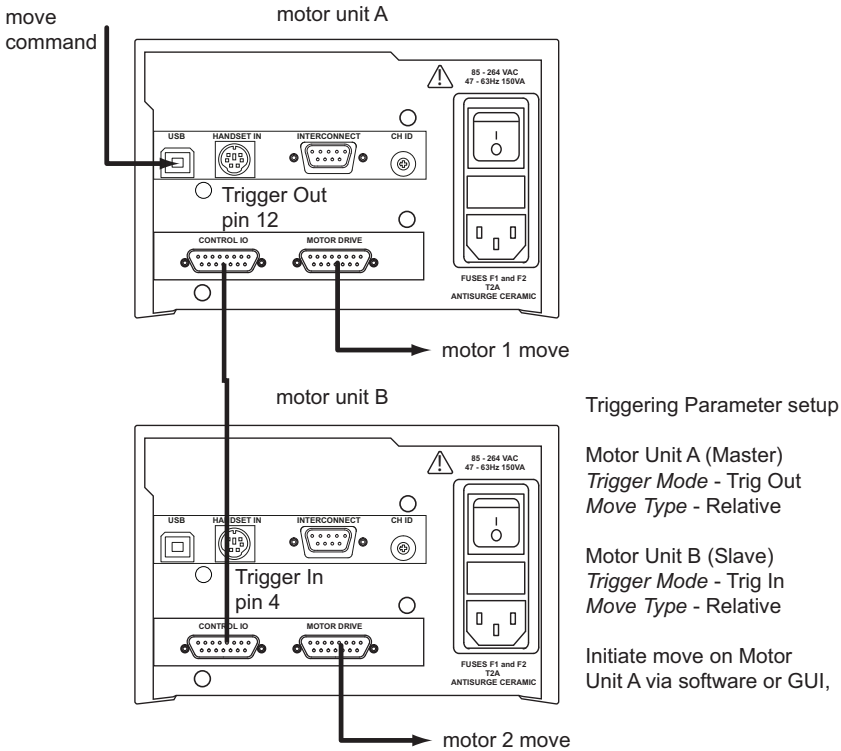

**Fig. 5.8 Typical Triggerring Set Up**

When the move command is received via the USB link, the motor associated with unit A starts to move by the specified relative distance. Unit A also sends a trigger signal to Unit B. Unit B has been set to 'Trig In', so on receipt of the trigger from unit A, the associated motor also starts to move.

*Persist Settings to Hardware* - The *Triggerring* parameters described earlier can be stored (persisted) within the unit itself, such that when the unit is next powered up these settings are applied automatically. This is particularly important when the driver is being used manually via a joystick, in the absence of a PC and USB link.

To save the settings to hardware, check the 'Persist Settings to Hardware' checkbox before clicking the 'OK button'.

### 5.3.4 Joystick Tab

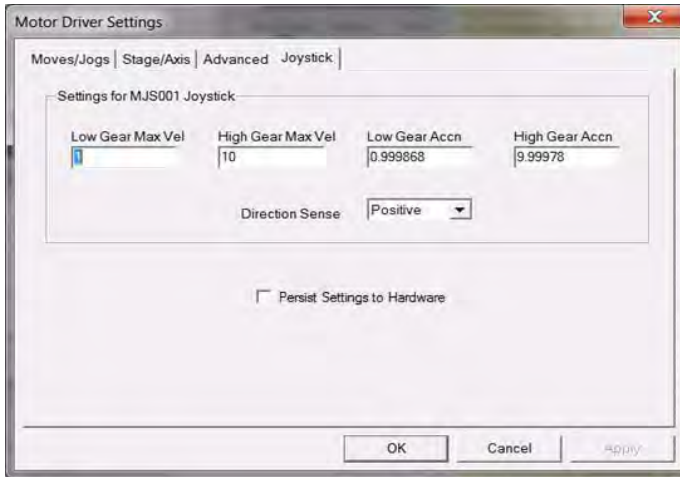

**Fig. 5.9 Joystick Settings**

If the optional Thorlabs joystick console is being used (MJC001) the following parameters are used to set the velocity and acceleration limits and the direction sense of any moves initiated from the joystick. - see Section 4.10. for more details on joystick use.

*Low Gear Max Vel* – The max velocity of a move when low gear mode is selected.

*High Gear Max Vel* – The max velocity of a move when high gear mode is selected.

*Low Gear Accn* – The acceleration of a move when low gear mode is selected.

*High Gear Accn* – The acceleration of a move when high gear mode is selected.

*Direction Sense* – The actual direction sense of any joystick initiated moves is dependent upon the application. This parameter can be used to reverse the sense of direction for a particular application and is useful when matching joystick direction sense to actual stage direction sense.

#### Note

**Joystick controlled moves always use a trapezoidal velocity profile.**

*Persist Settings to Hardware* - The *Joystick* Parameters described above can be stored (persisted) within the unit itself, such that when the unit is next powered up these settings are applied automatically. This is particularly important when the driver is being used manually via a joystick, in the absence of a PC and USB link.

To save the settings to hardware, check the 'Persist Settings to Hardware' checkbox before clicking the 'OK button'.

# Appendix A Rear Panel Connector Pinout Details

## A.1 Rear Panel Control IO Connector

The 'CONTROL I/O' connector exposes a number of electrical signals useful for external control. It is possible to configure a particular controller to respond to trigger inputs, generate trigger outputs or both respond to and generate a trigger output - see Section 5.3.3. Motor jogging lines can be used to jog the motor in both forward and reverse directions from a remote handset (Jogging parameters (e.g. jog distance) are set via the GUI panel - see Section 5.3.1.).

The pin functions are detailed in Fig. A.1.

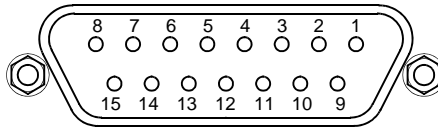

Pin	Description	Return	Pin	Description	Return
1	User 5V I/O	9	9	User 0V	–
2	* Jog forwards	9	10	* Jog backwards	9
3	Not Used	9	11	** Analog In	9
4	Tigger In	–	12	Trigger Out	9
5	User 0V	–	13	Not Used	5
6	Not Used	–	14	Not Used	6
7	Digital (User) In	–	15	Digital (User) Out	9
8	Keyed Pin	–			

### Notes

\* Jog inputs must be short circuit to User 0V (pin 9) in order to function.

\*\* Analog In is 0 to 5V wrt 0V (pin 9). The input can be read by calling the LLGetADCInputs method in the APT software - see the *APTServer helpfile* for more details.

Fig. A.1 MOTOR I/O connector pin identification

### A.1.1 Digital/User Outputs

All digital outputs are of the open-collector type, with a 330 Ohm series resistor. When the output is set to a logic zero (which is also the default state), it behaves as open circuit. When it is a logic one, it behaves as a 330 Ohm resistor connected to ground.

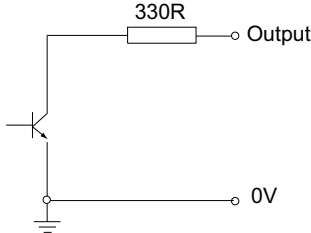

**Fig. A.2 Digital Output Schematic**

In some applications, the outputs may be required to control external equipment that has optocoupler type inputs (such as PLCs). The digital outputs used here can be used to directly drive most optocouplers and the +5V supply available on pins 14 and 15 can be used to provide power for the optocouplers.

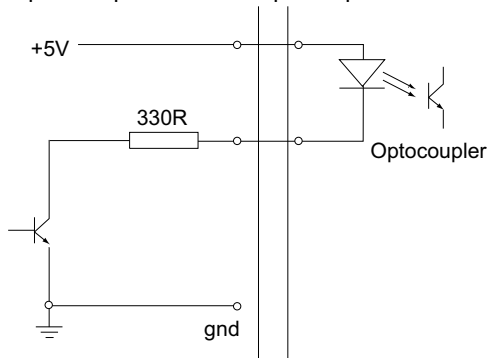

**Fig. A.3 Application Example: Connection to Optocoupler Inputs**

These outputs can also be used to interface to external logic circuitry (a pull-up resistor may be needed if the external logic does not contain it) or control other types of inputs.



#### Caution



**The voltage that external equipment applies to the digital outputs must be within the range 0 V and +5 V DC, or damage to the outputs may occur.**

Please see the LLSetGetDigOPs method in the APTServer helpfile for details on how to control these logic IO.

### A.1.2 Digital/User Inputs

The digital inputs used in the controller are of the standard CMOS logic gate type with TTL compatible input levels and a built-in pull-up resistor (10 kOhm to +5V). They can be connected directly to mechanical switches, open-collector type outputs or most type of logic outputs.

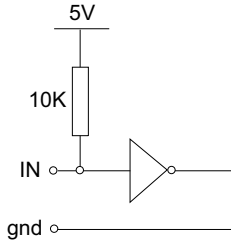

**Fig. A.4 Digital Input Schematic (protection circuitry not shown)**

When connected to a switch, the inputs will read as logic LOW if the switch is open circuit and HIGH if the switch is closed. When connected to a logic output, or any other voltage source, the input is guaranteed to read LOW if the voltage is above 2.4V and HIGH when the output is below 0.8 V. Please see the LLGetStatusBits method in the APTServer helpfile for details on how to control these logic IO.

**Caution**

**The voltage applied to the digital inputs must be within the range 0 V to +7V DC, or damage to the inputs may occur.**

### A.1.3 Trigger Output

The trigger output is different from the rest of the digital outputs in that it is a 5V CMOS logic gate with a series 1 kOhm resistor for protection. It behaves as +5V voltage source with 1 kOhm in series when the outputs is a logic HIGH, and 1 kOhm to ground when it is a logic LOW. The 1 kOhm resistor limits the current to 5 mA maximum for any load as long as the output is not connected to voltages outside the 0 V to +5V range.

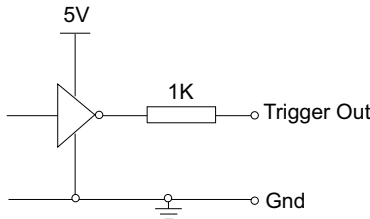

**Fig. A.5 Trigger Output Schematic**

As this output is actively driven, it can be connected, for example, to an oscilloscope without a need for an external pull-up resistor. It can also be used to drive most optocouplers.



#### A.1.4 Trigger Input

The Trigger inputs are electrically identical to the digital inputs (i.e. a standard CMOS logic gate type with TTL compatible input levels and a built-in pull-up resistor, 10 kOhm to +5V). They can be connected directly to mechanical switches, open-collector type outputs or most type of logic outputs.

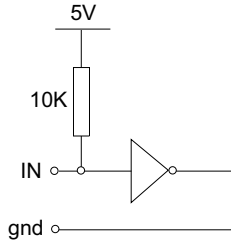

**Fig. A.6 Trigger Input Schematic (protection circuitry not shown)**

When connected to a switch, the inputs will read as logic LOW if the switch is open circuit and HIGH if the switch is closed. When connected to a logic output, or any other voltage source, the input is guaranteed to read LOW if the voltage is above 2.4V and HIGH when the output is below 0.8 V.



#### Caution



**The voltage applied to the trigger inputs must be within the range 0 V to +7V DC, or damage to the outputs may occur.**

#### A.1.5 +5 Volt Supply

A +5 V, 250 mA supply is provided for interfacing to external circuits that require a power source.



#### Caution



**Do not exceed the 250 mA maximum output current. For applications requiring higher currents an external power supply must be used.**

## A.2 Rear Panel HANDSET Connector

Provides connection to the MJC001 joystick. The pin functions are detailed in in Fig. A.7

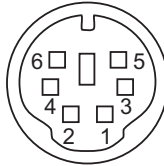

Pin	Description
1	RX (controller input)
2	Ground
3	Ground
4	+5V , 100 mA Supply for Joystick
5	TX (controller output)
6	Ground

Fig. A.7 HANDSET Connector Pin Identification

## A.3 Rear Panel MOTOR DRIVE Connectors

The 'MOTOR DRIVE' connector provides connection to the motors. The pin functions are detailed in Fig. A.8. .

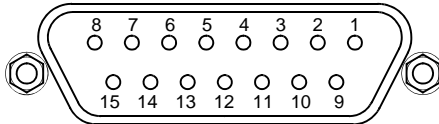

Pin	Description	Pin	Description
1	Encoder A +ve	9	CW Limit Swtich
2	Encoder A -ve	10	CCW Limit Switch
3	Encoder B +ve	11	0V User
4	Encoder B -ve	12	For Future Use
5	5V User	13	For Future Use
6	For Future Use	14	Motor Phase B +
7	Motor Phase B -	15	Motor Phase A +
8	Motor Phase A -		

Fig. A.8 DRIVE CHANNEL connector pin identification

#### **A.4 Rear Panel INTERCONNECT Connector**

The INTERCONNECT terminal on the rear panel is for future development, and is not implemented at this time.

---

## Appendix B Using A Virtual Comm Port

When using the low level communications protocol messages to develop client applications outside of the APT software, communication with the device is facilitated by using a virtual comms port can be configured as follows:

- 1) Open the device manager by selecting Start/Control Panel/Device Manager/

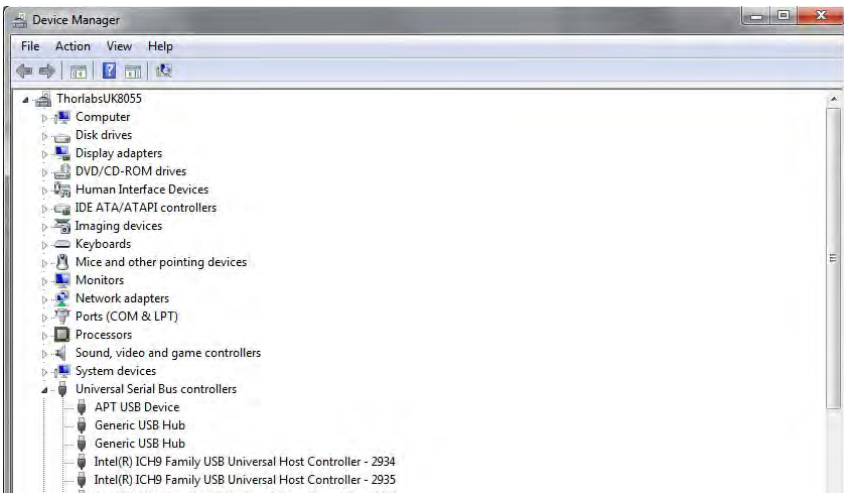

- 2) Click 'USB Serial Bus Controllers' and select the APT USB Device to be configured, then right click and select 'Properties'.

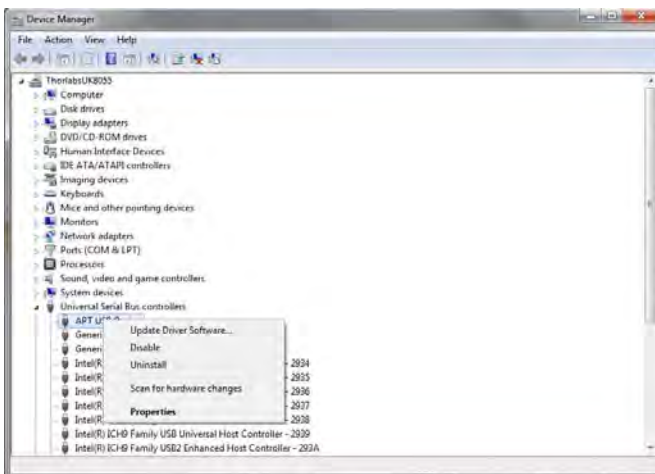

- 3) The 'USB Device Properties' window is displayed.

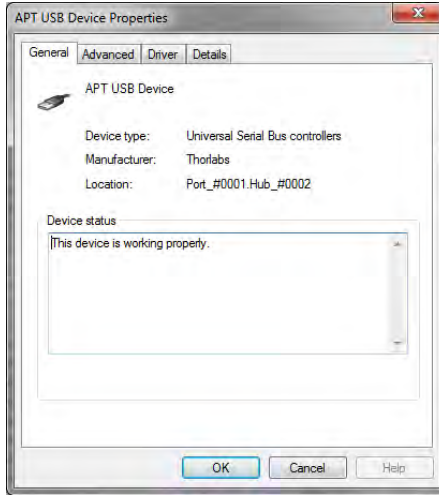

- 4) Select the 'Advanced' tab, and check the 'Load VCP' box.

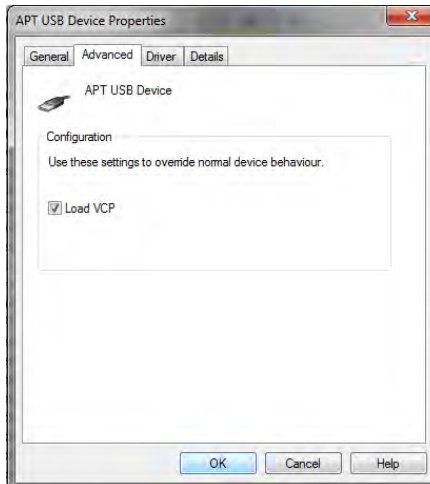

- 5) Click OK, then power cycle the device being configured.

- 6) In the device manager, click 'Ports (COM & LPT)', and note the 'APT USB Device Serial Port' COM port number (e.g. COM3).

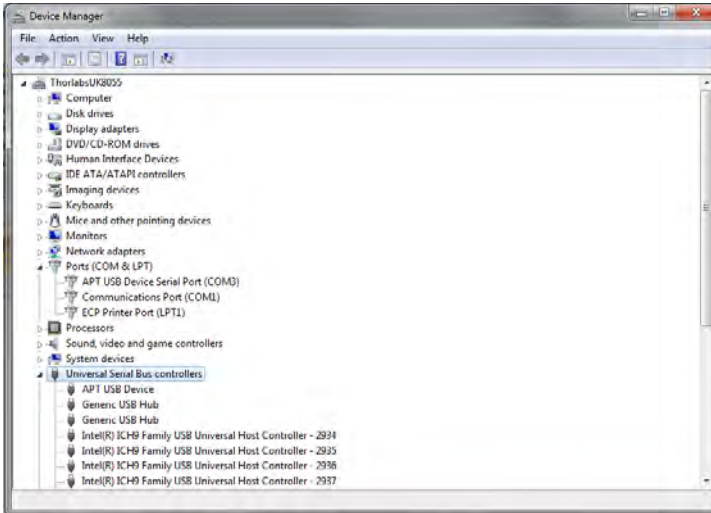

This COM port can then be used by the client application to communicate with the device using the low level protocol messages.

---

## Appendix C Preventive Maintenance



### Shock Warning



The equipment contains no user servicable parts. There is a risk of severe electrical shock if the equipment is operated with the covers removed. Only personnel authorized by Thorlabs Ltd and trained in the maintenance of this equipment should remove its covers or attempt any repairs or adjustments. Maintenance is limited to safety testing and cleaning as described in the following sections.

### C.1 Safety Testing

PAT testing in accordance with local regulations, should be performed on a regular basis, (typically annually for an instrument in daily use).



### Caution



The instrument contains a power supply filter. Insulation testing of the power supply connector should be performed using a DC voltage.

### C.2 Cleaning

The fascia may be cleaned with a soft cloth, lightly dampened with water or a mild detergent.



### Warning



**Disconnect the power supply before cleaning the unit.**  
**Never allow water to get inside the case.**  
**Do not saturate the unit.**  
**Do not use any type of abrasive pad, scouring powder or solvent, e.g. alcohol or benzene.**

## Appendix D Specifications and Associated Parts

### D.1 Specifications

Parameter	Value
<b>Input/Output</b>	
Motor Drive Channel (15-Pin D-type Female)	2-Phase Bipolar Motor Drive Output Differential Quadrature Encoder Interface Forward, Reverse Limit Switch Inputs
Motor Control (15-Pin D-type Female)	Jog Forward Jog Back User Outputs/Inputs Single - ended analog input (0-10 Volt) Trigger In/Out
<b>Resolution</b>	2048 Microsteps per Full Step 200 Step Motor - 409600 Microsteps per Rev
<b>Motor Power</b>	Up to 48 V/50 W (peak)
<b>Input Power Requirements</b>	
Voltage	85-264 VAC
Power	100 W
Fuse	3.15 A
<b>Motor speeds</b>	Up to 3000 RPM (for 200 full step motor)
<b>Encoder feedback bandwidth</b>	500,000 counts/sec
<b>General</b>	
Housing Dimensions (W x D x H)	152 x 244 x 104 mm (6 x 9.6 x 4.1 in.)
Instrument Weight	3.18 kg (7 lbs)
<b>Compatible Motors</b>	
Peak Powers	5 to 50 W
Average Power	25 W Maximum
Step Angle Range	20° to 1.8°
Coil Resistance (nominal)	4 to 15 Ω
Coil Inductance (nominal)	4 to 15 mH
Rated Phase Currents (nominal)	100 mA to 1 A



## D.2 Associated Products

Product Name	Part Number
Stepper Motor Actuator, 4mm travel	DRV001
Stepper Motor Actuator, 25mm (1") travel, trapezoidal leadscrew	DRV013
Stepper Motor Actuator, 50mm (2") travel, trapezoidal leadscrew	DRV014
Stepper Motor Drive Cable (1.25 Metres)	PAA 610
Stepper Motor Drive Cable (3.0 Metres)	PAA 611

---

## Appendix E Motor Control Method Summary

The 'Motor' ActiveX Control provides the functionality required for a client application to control one or more of the APT series of motor controller units.

To specify the particular controller being addressed, every unit is factory programmed with a unique 8-digit serial number. This serial number is key to the operation of the APT Server software and is used by the Server to enumerate and communicate independently with multiple hardware units connected on the same USB bus. The serial number must be specified using the HWSerialNum property before an ActiveX control instance can communicate with the hardware unit. This can be done at design time or at run time. Note that the appearance of the ActiveX Control GUI (graphical user interface) will change to the required format when the serial number has been entered.

The Methods and Properties of the Motor ActiveX Control can be used to perform activities such as homing stages, absolute and relative moves, and changing velocity profile settings. A brief summary of each method and property is given below, for more detailed information and individual parameter descriptions please see the on-line help file supplied with the APT server.

### Methods

CalibrateEnc	Calibrates encoder equipped stage.
DeleteParamSet	Deletes stored settings for specific controller.
DisableHWChannel	Disables the drive output.
DoEvents	Allows client application to process other activity.
EnableHWChannel	Enables the drive output.
GetAbsMovePos	Gets the absolute move position.
GetAbsMovePos_AbsPos	Gets the absolute move position (returned by value).
GetBLashDist	Gets the backlash distance.
GetBLashDist_BLashDist	Gets the backlash distance (returned by value).
GetCtrlStarted	Gets the ActiveX Control started flag.
GetDispMode	Gets the GUI display mode.
GetEncCalibTableParams	Gets the encoder calibration table parameters for encoder equipped stages.
GetEncPosControlParams	Gets the encoder position control parameters for encoder equipped stages.
GetEncPosCorrectParams	Gets the encoder position correction parameters for encoder equipped stages.

GetHomeParams	Gets the homing sequence parameters.
GetHomeParams_HomeVel	Gets the homing velocity parameter (returned by value).
GetHomeParams_ZeroOffset	Gets the homing zero offset parameter (returned by value).
GetHWCommsOK	Gets the hardware communications OK flag.
GetHWLimSwitches	Gets the limit switch configuration settings.
GetJogMode	Gets the jogging button operating modes.
GetJogMode_Mode	Get the jogging button operating mode (returned by value).
GetJogMode_StopMode	Gets the jogging button stopping mode (returned by value).
GetJogStepSize	Gets the jogging step size.
GetJogStepSize_StepSize	Gets the jogging step size (returned by value).
GetJogVelParams	Gets the jogging velocity profile parameters.
GetJogVelParams_Accn	Gets the jogging acceleration parameter (returned by value).
GetJogVelParams_MaxVel	Gets the jogging maximum velocity parameter (returned by value).
GetMotorParams	Gets the motor gearing parameters.
GetParentHWInfo	Gets the identification information of the host controller.
GetPosition	Gets the current motor position.
GetPosition_Position	Gets the current motor position (returned by value).
GetPositionEx	Gets the current motor position.
GetPositionEx_UncalibPosition	Gets the current uncalibrated motor position (returned by value).
GetPositionOffset	Gets the motor position offset.
GetRelMoveDist	Gets the relative move distance.
GetRelMoveDist_RelDist	Gets the relative move distance (returned by reference).
GetStageAxis	Gets the stage type information associated with the motor under control.
GetStageAxisInfo	Gets the stage axis parameters.
GetStageAxisInfo_MaxPos	Gets the stage maximum position (returned by value).
GetStageAxisInfo_MinPos	Gets the stage minimum position (returned by value).

GetStatusBits_Bits	Gets the controller status bits encoded in 32 bit integer (returned by value).
GetTriggerParams	Gets the move triggering parameters.
GetVelParamLimits	Gets the maximum velocity profile parameter limits.
GetVelParams	Gets the velocity profile parameters.
GetVelParams_Accn	Gets the move acceleration (returned by value).
GetVelParams_MaxVel	Gets the move maximum velocity (returned by value).
Identify	Identifies the controller by flashing unit LEDs.
LLGetDigIPs	Gets digital input states encoded in 32 bit integer.
LLGetStatusBits	Gets the controller status bits encoded in 32 bit integer.
LLSetGetDigOPs	Sets or Gets the user digital output bits encoded in 32 bit integer.
LoadParamSet	Loads stored settings for specific controller.
MoveAbsolute	Initiates an absolute move.
MoveAbsoluteEnc	Initiates an absolute move with specified positions for encoder equipped stages.
MoveAbsoluteEx	Initiates an absolute move with specified positions.
MoveAbsoluteRot	Initiates an absolute move with specified positions for rotary stages.
MoveHome	Initiates a homing sequence.
MoveJog	Initiates a jog move.
MoveRelative	Initiates a relative move.
MoveRelativeEnc	Initiates a relative move with specified distances for encoder equipped stages.
MoveRelativeEx	Initiates a relative move with specified distances.
MoveVelocity	Initiates a move at constant velocity with no end point.
SaveParamSet	Saves settings for a specific controller.
SetAbsMovePos	Sets the absolute move position.
SetBLashDist	Sets the backlash distance.
SetChannelSwitch	Sets the GUI channel switch position.
SetDispMode	Sets the GUI display mode.
SetEncCalibTableParams	Sets the encoder calibration table parameters for encoder equipped stages.
SetEncPosControlParams	Sets the encoder position control parameters for encoder equipped stages.

SetEncPosCorrectParams	Sets the encoder position correction parameters for encoder equipped stages.
SetHomeParams	Sets the homing sequence parameters.
SetHWLimSwitches	Sets the limit switch configuration settings.
SetJogMode	Sets the jogging button operating modes.
SetJogStepSize	Sets the jogging step size.
SetJogVelParams	Sets the jogging velocity profile parameters.
SetMotorParams	Sets the motor gearing parameters.
SetPositionOffset	Sets the motor position offset.
SetPotParams	Sets the velocity control potentiometer parameters (Cube drivers).
SetRelMoveDist	Sets the relative move distance.
SetStageAxisInfo	Sets the stage axis parameters.
SetTriggerParams	Sets the move triggering parameters.
SetVelParams	Sets the velocity profile parameters.
ShowSettingsDlg	Display the GUI Settings panel.
StartCtrl	Starts the ActiveX Control (starts communication with controller)
StopCtrl	Stops the ActiveX Control (stops communication with controller)
StopImmediate	Stops a motor move immediately.
StopProfiled	Stops a motor move in a profiled (deceleration) manner.

### Properties

APTHelp	Specifies the help file that will be accessed when the user presses the F1 key. If APTHelp is set to 'True', the main server helpfile <i>APTServer</i> will be launched.
DisplayMode	Allows the display mode of the virtual display panel to be set/read.
HWSerialNum	specifies the serial number of the hardware unit to be associated with an ActiveX control instance.

---

# Appendix F Stepper Motor Operation - Background

## F.1 How A Stepper Motor Works

### F.1.1 General Principle

Thorlabs' actuators use a stepper motor to drive a precision lead screw.

Stepper motors operate using the principle of magnetic attraction and repulsion to convert digital pulses into mechanical shaft rotation. The amount of rotation achieved is directly proportional to the number of input pulses generated and the speed is proportional to the frequency of these pulses. A basic stepper motor has a permanent magnet and/or an iron rotor, together with a stator. The torque required to rotate the stepper motor is generated by switching (commutating) the current in the stator coils as illustrated in Fig. F.1.

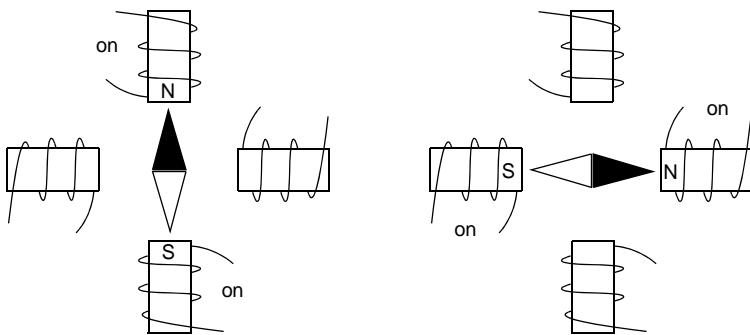

**Fig. F.1 Simplified concept of stepper motor operation**

Although only 4 stator poles are shown above, in reality there are numerous tooth-like poles on both the rotor and stator. The result is that positional increments (steps) of 1.8 degrees can be achieved by switching the coils (i.e. 200 steps per revolution). If the current through one coil is increased as it is decreased in another, the new rotor position is somewhere between the two coils and the step size is a defined fraction of a full step (microstep).

The size of the microstep depends on the resolution of the driver electronics. When used with the Thorlabs BSC201 Stepper Motor Controller, the smallest angular adjustment is 0.000879 degrees (i.e.  $1.8/0.000879 = 2048$  microsteps per full step), resulting in a resolution of 409,600 microsteps per revolution for a 200 full step motor.

In practise, the mechanical resolution achieved by the system may be coarser than a single microstep, primarily because there may be a small difference between the orientation of the magnetic field generated by the stator and the orientation in which the rotor comes to rest.

### F.1.2 Positive and Negative Moves

*Positive* and *negative* are used to describe the direction of a move. A positive move means a move from a smaller absolute position to a larger one, a negative move means the opposite.

In the case of a linear actuator, a positive move takes the platform of the stage further away from the motor.

In a rotational stage, a positive move turns the platform clockwise when viewed from above.

### F.1.3 Velocity Profiles

To prevent the motor from stalling, it must be ramped up gradually to its maximum velocity. Certain limits to velocity and acceleration result from the torque and speed limits of the motor, and the inertia and friction of the parts it drives.

The system incorporates a trajectory generator, which performs calculations to determine the instantaneous position, velocity and acceleration of each axis at any given moment. During a motion profile, these values will change continuously. Once the move is complete, these parameters will then remain unchanged until the next move begins.

The specific move profile created by the system depends on several factors, such as the profile mode and profile parameters presently selected, and other conditions such as whether a motion stop has been requested. The profile mode can be set to 'Trapezoidal' or 'Bow Index' as described in Section 5.3.1.

The *Trapezoidal* profile is a standard, symmetrical acceleration/deceleration motion curve, in which the start velocity is always zero. This profile is selected when the *Bow Index* field is set to '0'.

In a typical trapezoidal velocity profile, (see Fig. 5.4.), the stage is ramped at acceleration ' $a$ ' to a maximum velocity ' $v$ '. As the destination is approached, the stage is decelerated at ' $a$ ' so that the final position is approached slowly in a controlled manner.

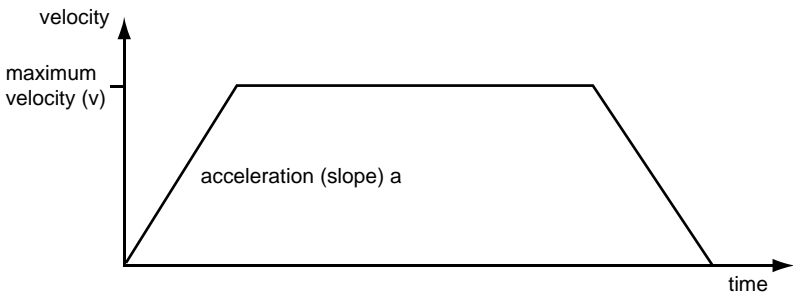

Fig. 6.2 Graph of a trapezoidal velocity profile

The S-curve profile is a trapezoidal curve with an additional 'Bow Value' parameter, which limits the rate of change of acceleration and smooths out the contours of the motion profile. The Bow Value is specified in mm/s<sup>3</sup> and is derived from the Bow Index field as follows:

The Bow Value is applied in mm/s<sup>3</sup> and is derived from the Bow Index field as follows:

Bow Value =  $2^{(\text{Bow Index} - 1)}$  within the range 1 to 262144 (Bow Index 1 to 18).

In this profile mode, the acceleration increases gradually from 0 to the specified acceleration value, then decreases at the same rate until it reaches 0 again at the specified velocity. The same sequence in reverse brings the axis to a stop at the programmed destination position.

Example

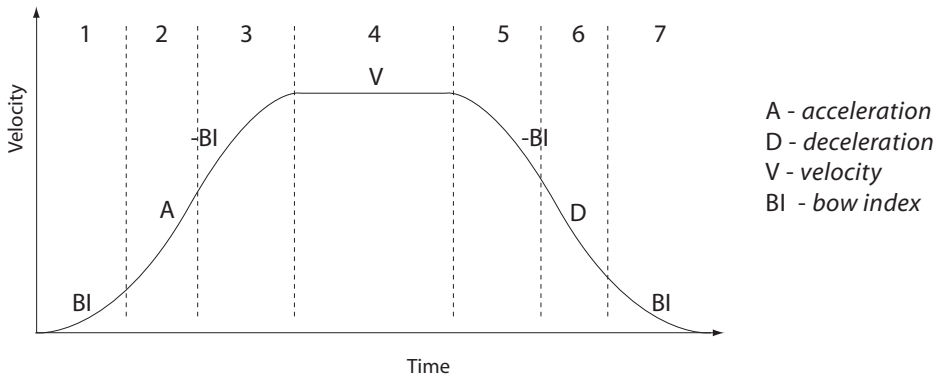

**Fig. 6.3 Typical S-Curve Profile**

The figure above shows a typical S-curve profile. In segment (1), the S-curve profile drives the axis at the specified Bow Index (BI) until the maximum acceleration (A) is reached. The axis continues to accelerate linearly (Bow Index = 0) through segment (2). The profile then applies the negative value of Bow Index to reduce the acceleration to 0 during segment (3). The axis is now at the maximum velocity (V), at which it continues through segment (4). The profile then decelerates in a similar manner to the acceleration phase, using the Bow Index to reach the maximum deceleration (D) and then bring the axis to a stop at the destination.

**Note**

**The higher the Bow Index, then the shorter the BI phases of the curve, and the steeper the acceleration and deceleration phases. High values of Bow Index may cause a move to overshoot.**



## F.2 Positioning a Stage

### F.2.1 General

Whenever a command is received to move a stage, the movement is specified in motion units, (e.g. millimetres). This motion unit value is converted to microsteps before it is sent to the stage. If operating the unit by the front panel (local mode) this conversion is performed internally by the controller. If operating via a PC (remote mode) then the conversion is performed by the APT software.

Each motor in the system has an associated electronic counter in the controller, which keeps a record of the net number of microsteps moved. If a request is received to report the position, the value of this counter is converted back into motion units.

### F.2.2 Home position

When the system is powered up, the position counters in the controller are all set to zero and consequently, the system has no way of knowing the position of the stage in relation to any physical datum.

A datum can be established by sending all the motors to their 'Home' positions. The 'Home' position is set during manufacture and is determined by driving the motor until the negative limit switch is reached and then driving positively a fixed distance (zero offset). When at the Home position, the counters are reset to zero thereby establishing a fixed datum that can be found even after the system has been switched off.

See Section 4.3. for details on performing a Home move.

### F.2.3 Limit Switches

A linear stage moves between two stops, and movement outside these limits is physically impossible. Linear stages can include stages that control the angle of a platform within a certain range, although the movement of the platform is not really linear but angular. Rotary stages can rotate indefinitely, like a wheel.

Linear and rotary stages both contain microswitches that detect certain positions of the stage, but they differ in the way these switches are used.

All linear stages have a –ve limit switch, to prevent the stage from accidentally being moved too far in the –ve direction. Once this switch is activated, movement stops. The switch also provides a physical datum used to find the Home position. Some linear stages and actuators also have a +ve limit switch, whereas others rely on a physical stop to halt the motion in the positive direction. A rotary stage has only one switch,

used to provide a datum so that the Home position can be found. Movement is allowed right through the switch position in either direction.

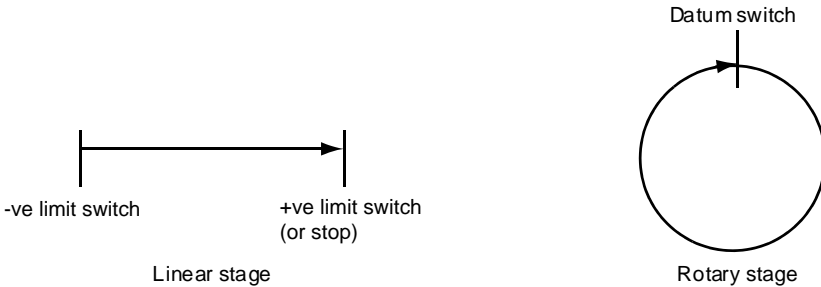

**Fig. F.4 Stage limit switches**

#### F.2.4 Minimum and Maximum Positions

These positions are dependent upon the stage or actuator to which the motors are fitted, and are defined as the minimum and maximum useful positions of the stage relative to the 'Home' position - see Fig. F.5.

The distance from the Minimum position to the Maximum position is the 'useful travel' of the stage. It is often the case that the Minimum position is zero. The Home and Minimum positions then coincide, with movement always occurring on the positive side of the Home position.

Rotary stages have effectively no limits of travel. The Minimum and Maximum positions are conventionally set to 0 and 360 degrees respectively. When the position of a rotary stage is requested, the answer will be reported as a number between 0 and 360 degrees, measured in the positive direction from the Home position.

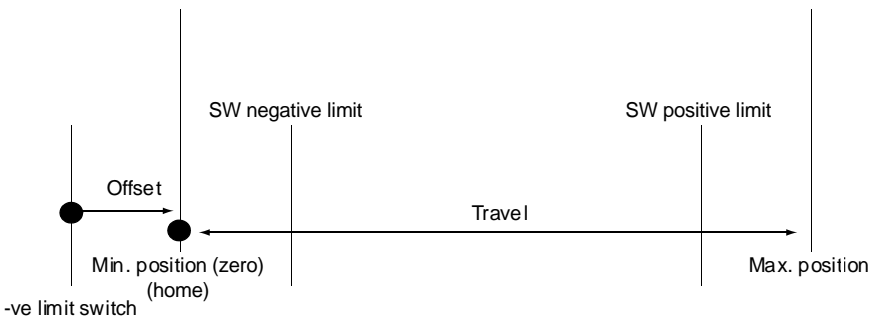

**Fig. F.5 Minimum and Maximum Positions**

### F.2.5 Power Saving

The current needed to hold a motor in a fixed position is much smaller than the current needed to move it, and it is advantageous to reduce the current through a stationary motor in order to reduce heating. Although this heating does not harm the motor or stage, it is often undesirable because it can cause thermal movements through expansion of the metal of the stage.

For this reason, power saving is implemented by default from the software drivers.

When a motor is moving, the 'Move Power' is applied. When a motor is stationary, the 'Rest Power' is applied. See 'Phase Powers' in Section 5.3.3. for more details on these power settings.

## F.3 Error Correction

### F.3.1 Backlash correction

The term *backlash* refers to the tendency of the stage to reach a different position depending on the direction of approach.

Backlash can be overcome by always making the last portion of a move in the same direction, conventionally the positive direction. Consider the situation in Fig. 6.6, a *positive* move, from 10 to 20 mm, is carried out as one simple move, whereas a *negative* move, from 20 to 10 mm, first causes the stage to overshoot the target position and then move positively through a small amount.

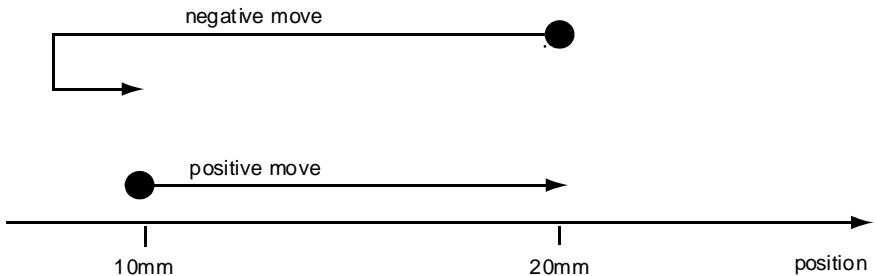

Fig. 6.6 Backlash correction

The controller has this type of 'backlash correction' enabled as its default mode of operation, but it can be overridden if the overshoot part of the move is unacceptable for a particular application.

See Chapter 5 for details on setting the backlash correction.

---

# Appendix G Regulatory

## G.1 Declarations Of Conformity

### G.1.1 For Customers in Europe

This equipment has been tested and found to comply with the EC Directives 2004/108/EC 'EMC Directive' and 2006/95/EC 'Low Voltage Directive'.

Compliance was demonstrated by conformance to the following specifications which have been listed in the Official Journal of the European Communities:

Safety EN61010-1: 2010 Safety requirements for electrical equipment for measurement, control and laboratory use.

EMC EN61326-1: 2006 Electrical equipment for measurement, control and laboratory use - EMC requirements.

### G.1.2 For Customers In The USA

This equipment has been tested and found to comply with the limits for a Class A digital device, pursuant to part 15 of the FCC rules. These limits are designed to provide reasonable protection against harmful interference when the equipment is operated in a commercial environment. This equipment generates, uses and can radiate radio frequency energy and, if not installed and used in accordance with the instruction manual, may cause harmful interference to radio communications. Operation of this equipment in a residential area is likely to cause harmful interference in which case the user will be required to correct the interference at his own expense. Changes or modifications not expressly approved by the company could void the user's authority to operate the equipment.

## G.2 Waste Electrical and Electronic Equipment (WEEE) Directive

### G.2.1 Compliance

As required by the Waste Electrical and Electronic Equipment (WEEE) Directive of the European Community and the corresponding national laws, we offer all end users in the EC the possibility to return "end of life" units without incurring disposal charges.

This offer is valid for electrical and electronic equipment

- sold after August 13th 2005
- marked correspondingly with the crossed out "wheelie bin" logo (see Fig. 1)
- sold to a company or institute within the EC
- currently owned by a company or institute within the EC
- still complete, not disassembled and not contaminated



**Fig. 7.1** Crossed out "wheelie bin" symbol

As the WEEE directive applies to self contained operational electrical and electronic products, this "end of life" take back service does not refer to other products, such as

- pure OEM products, that means assemblies to be built into a unit by the user (e. g. OEM laser driver cards)
- components
- mechanics and optics
- left over parts of units disassembled by the user (PCB's, housings etc.).

If you wish to return a unit for waste recovery, please contact Thorlabs or your nearest dealer for further information.

#### G.2.2 Waste treatment on your own responsibility

If you do not return an "end of life" unit to the company, you must hand it to a company specialized in waste recovery. Do not dispose of the unit in a litter bin or at a public waste disposal site.

#### G.2.3 Ecological background

It is well known that WEEE pollutes the environment by releasing toxic products during decomposition. The aim of the European RoHS directive is to reduce the content of toxic substances in electronic products in the future.

The intent of the WEEE directive is to enforce the recycling of WEEE. A controlled recycling of end of life products will thereby avoid negative impacts on the environment.

G.3 CE Certificate



EU Declaration of Conformity

in accordance with EN ISO 17050-1:2010

We Thorlabs Ltd  
Of 1 Saint Thomas Place, Ely, Cambridgeshire, CB7 4EX

in accordance with the following Directive(s):

- 2006/95/EC Low Voltage (LVD)
- 2004/108/EC Electromagnetic Compatibility (EMC)
- 2011/65/EU Restriction of use of certain hazardous substances (RoHS)

hereby declare that:

Equipment *Single Channel Benchtop Stepper Motor Controller*  
Model Number BSC201

is in conformity with the applicable requirements of the following documents:

- EN61010 -1 Safety requirements for electrical equipment for measurement, control and laboratory use. 2010
- EN61326-1 Electrical Equipment for measurement, control and laboratory use - EMC requirements 2006

and which is in conformity with Directive 2011/65/EU of the European Parliament and of the Council of 8th June 2011 on the restriction of the use of certain hazardous substances in electrical and electronic equipment, for the reasons stated below:

- A does not contain substances in excess of the maximum concentration values tolerated by weight in homogenous materials as listed in Annex II of the Directive

I hereby declare that the equipment named above has been designed to comply with the relevant sections of the above referenced specifications. The unit complies with all applicable Essential Requirements of the Directives.  
Signed:

Name: Keith Dhese  
Position: General Manager  
On: 30 August 2013



EDC - 2013-09-02 - Sin -BSC201

---

## Appendix H Thorlabs Worldwide Contacts

### USA, Canada, and South America

Thorlabs, Inc.  
56 Sparta Ave  
Newton, NJ 07860  
USA  
Tel: 973-579-7227  
Fax: 973-300-3600  
www.thorlabs.com  
www.thorlabs.us (West Coast)  
email: feedback@thorlabs.com  
Support: techsupport@thorlabs.com

### Europe

Thorlabs GmbH  
Hans-Böckler-Str. 6  
85221 Dachau  
Germany  
Tel: +49-(0)8131-5956-0  
Fax: +49-(0)8131-5956-99  
www.thorlabs.de  
email: Europe@thorlabs.com

### UK and Ireland

Thorlabs Ltd.  
1 Saint Thomas Place, Ely  
Cambridgeshire CB7 4EX  
Great Britain  
Tel: +44 (0)1353-654440  
Fax: +44 (0)1353-654444  
www.thorlabs.de  
email: sales.uk@thorlabs.com  
Support: techsupport.uk@thorlabs.com

### France

Thorlabs SAS  
109, rue des Côtes  
78600 Maisons-Laffitte  
France  
Tel: +33 (0) 970 444 844  
Fax: +33 (0) 811 381 748  
www.thorlabs.de  
email: sales.fr@thorlabs.com

### Scandinavia

Thorlabs Sweden AB  
Box 141 94  
400 20 Göteborg  
Sweden  
Tel: +46-31-733-30-00  
Fax: +46-31-703-40-45  
www.thorlabs.de  
email: scandinavia@thorlabs.com

### Japan

Thorlabs Japan Inc.  
Higashi Ikebukuro  
Q Building 1st Floor 2-23-2  
Toshima-ku, Tokyo 170-0013  
Japan  
Tel: +81-3-5979-8889  
Fax: +81-3-5979-7285  
www.thorlabs.jp  
email: sales@thorlabs.jp

### China

Thorlabs China  
Oasis Middlering Centre  
3 Building 712 Room  
915 Zhen Bei Road  
Shanghai  
China  
Tel: +86 (0)21-32513486  
Fax: +86 (0)21-32513480  
www.thorlabs.com  
email: chinasales@thorlabs.com

### Brazil

Thorlabs Vendas de Fotônicos Ltda.  
Rua Riachuelo, 171  
São Carlos, SP 13560-110  
Brazil  
Tel: +55-16-3413 7062  
Fax: +55-16-3413 7064  
www.thorlabs.com  
Email: brasil@thorlabs.com



Thorlabs Inc.  
56 Sparta Ave  
Newton, NJ07860  
USA  
Tel: +1 973 579 7227  
Fax: +1 973 300 3600  
[www.thorlabs.com](http://www.thorlabs.com)

Thorlabs Ltd.  
Saint Thomas Place, Ely  
Cambridgeshire CB7 4EX,  
UK  
Tel: +44 (0) 1353 654440  
Fax: +44 (0) 1353 654444  
[www.thorlabs.com](http://www.thorlabs.com)

---