

Solutions for Fluid Technology



VS + VSI
GEAR FLOW METERS

VS POSITIVE DISPLACEMENT FLOW METERS

VS FLOW METER

VS positive displacement flow meters are volume rate measuring sensors based on the meshing gear principle and are designed for use with liquids. Two precisely matched gear wheels are enclosed in a very accurately machined housing. Gear rotation is sensed by a non-contacting signal pick-up system. Each tooth produces one impulse.

The space between the gear teeth, when fully enclosed on both sides by the housing, constitutes measuring chambers. Fluid flow causes the gears to rotate and the incoming flow is separated into discrete volumes within these chambers i. e. the volume of liquid passing through the unit will cause rotation of the gears by exactly one tooth pitch.

This volume is known as the Volume/Impulse (V_m) and is stated in cc/Imp. It is used to define the size of a flow meter.

EXPLANATIONS FOR PREAMPLIFIER OF SIGNAL PICK-UP SYSTEM

The non-contact pick-up sensors consist of two differential magneto resistors, which are circumferentially offset from one another by 1/4 of a tooth pitch. The signals of both pick-up sensors are digitised with two signal amplifiers and amplified via followed short circuit proof push-pull output stages.

The square wave output signals are bidirectional and may be simply processed by any external electronics, plc control or computer. The processing of the 90° phase angle between signals enables recognition of flow direction and impulse rate conversion with a factor of 1, 2 and 4.

The signal frequency is proportional to the momentary flow rate (volume rate) dependent on the particular flow meter size. The frequency range extends from 0 – 2000 Hz. The preamplifier is protected against reverse polarity and incorrect connection. For medium temperatures between -40°C and 120°C (-22°F and 248°F) the unit is mounted directly on the flow meter cover.

SENSOR SYSTEMS FOR EXTENDED TEMPERATURE RANGE

For liquid temperatures from -40°C up to 210°C a special pick up system is available.

VSI HIGH DEFINITION PREAMPLIFIER

The VSI High Definition Preamplifier supplies digital signals with a higher resolution of the measured value. The high definition preamplifier is available in two versions.

The first version has a selectable resolution between 4 and 64 angle steps which enables an increase of the K-factor by 16 or 64 with a flank evaluation. The other version offers more performance. A very big advantage is the compatibility. With this version, preamplifiers of the standard VS and the VSI series are interchangeable. The customer can therefore easily replace or upgrade a preamplifier himself. In addition, this preamplifier electronics offers an selectable resolution between 4 and 128 angular steps, which allows a maximum increase of the K-factor by 32 or 128 with a flank evaluation.

EX-TYPES

Intrinsically safe models, with approval code  II 1G Ex ia IIC T4-T6, are supplied for applications in potentially explosion-hazardous areas. VSE delivers these types with isolation switch amplifier models MK 13 P Ex 0/24 VDC/K15.

VS FLOW METER SELECTION

For trouble-free and safe operation of the flow meters the correct selection of type and size is decisive. Due to the great number of different applications and flow meter versions, the technical data in the VSE catalogues are of general character.

Certain characteristics of the devices depend on type, size and measuring range as well as on the medium to be measured. For exact flow meter selection please contact VSE.

The current publication of this catalogue supersedes all information from previous publications. VSE reserves the right to make changes and substitutions. VSE is not liable for any printing errors. Reproduction, including excerpts, is permitted only after written approval by VSE. Last revised: 10/2020

OUTPUT SIGNALS OF PREAMPLIFIER

FLOW METER VS 0.02... VS 4

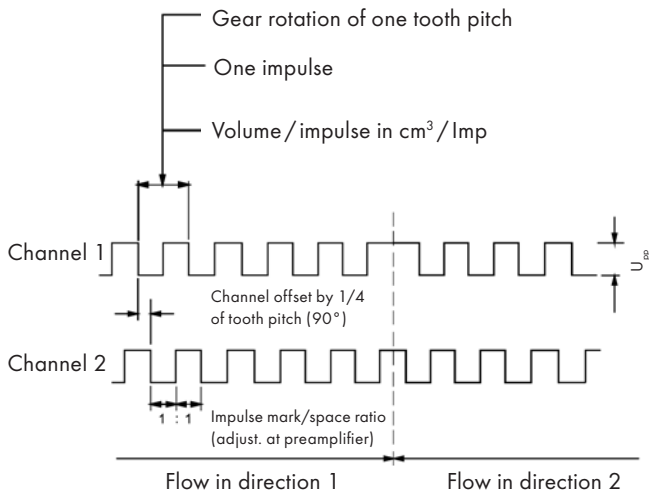

FLOW METER VS 10

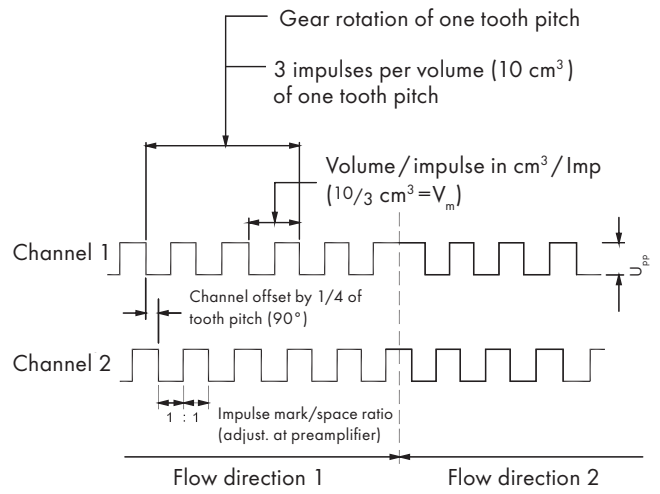

VOLTAGE RANGES

Supply voltages: $U_v = 10 \dots 28 \text{ V DC}$
 Impulse voltages: $U_{pp} = U_v - 1 \text{ V}$

VOLTAGE RANGES

Supply voltages: $U_v = 10 \dots 28 \text{ V DC}$
 Impulse voltages: $U_{pp} = U_v - 1 \text{ V}$

BLOCK DIAGRAM

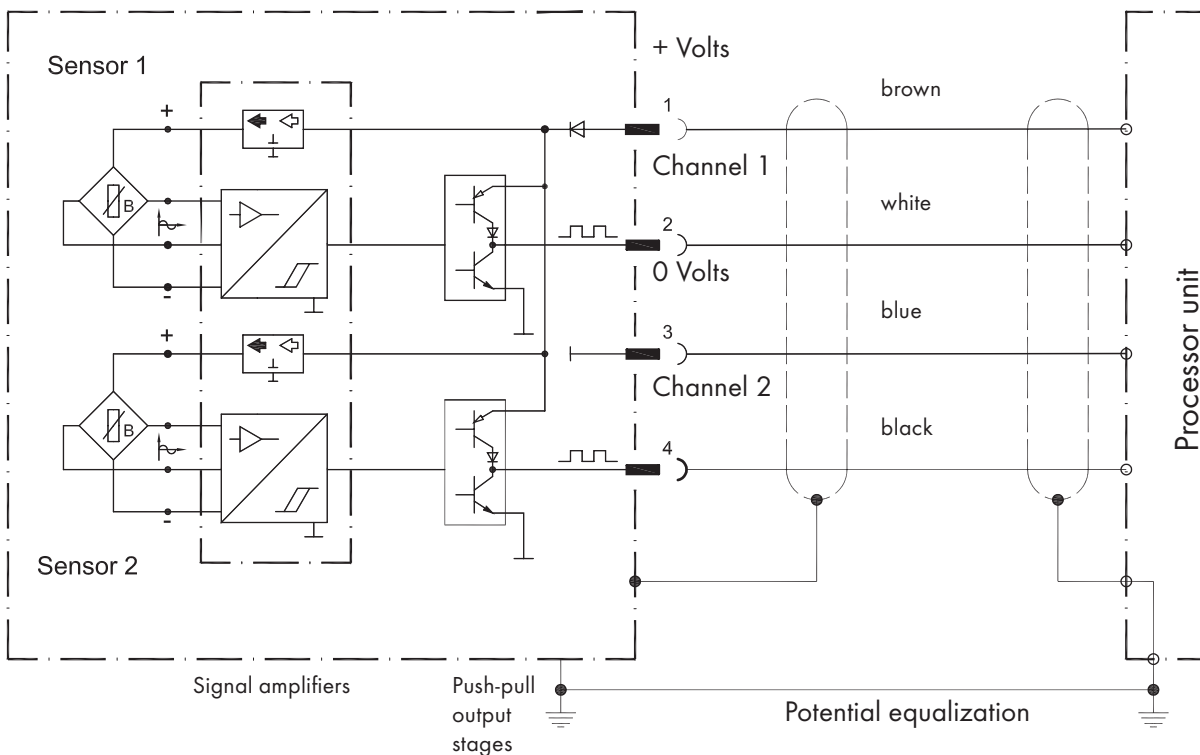

RANGES OF APPLICATIONS

APPLICATIONS

All liquids that can be pumped and have known lubrication properties can be measured, for example: paraffin, kerosene, benzine, diesel, Skydrol, mineral oils, hydraulic oils including fire resistant fluids, inks, dyes and paints, greases, polyurethane, polyol and isocyanates, Araldite, glues, pastes and creams, resins, waxes and many others.

RANGES OF APPLICATIONS IN THE AUTOMOTIVE INDUSTRY

Braking system test stands

Fuel consumption measurement

Polyurethane foams for steering wheels, fascia, seats etc.

Paint spraying systems

Steering systems

Batching and filling of motor oils, brake fluids, anti-freeze, corrosion preventatives, waxes etc.

Adhesive coatings for windscreens, headlights, engine housings etc.

HYDRAULICS

Volume and flow rate measurement

Leakage and rupture monitoring

Cylinder speed and position measurement

Positioning and step control

Measurement, control and regulation of flow rates and volumes

Test stands for pumps, motors, valves, proportionals and servo-valves

Synchronised multi-cylinder monitoring

Filling and additive blending

DYES AND PAINTS

Paint spraying systems

Batching and filling

Volume, flow rate and consumption

Monitoring of mixing ratios

PLASTICS TECHNOLOGY

Mixing, moulding and batching systems for single and multicomponent fluid plastics

Consumption measurement of e.g.:

Epoxy adhesives and potting compounds (resins and hardeners) for transformers, coils, relays, condensers, armatures, initiators, auto-electronics

Measuring, control and regulation of single components and mixing ratios

Silicon potting compounds

Polyurethane foams (polyol and isocyanate) for steering wheels, seals, shoes, soles, surf boards, furniture, computer casings, isolation etc.

Hot adhesive

CHEMICAL INDUSTRY

Flow rate and volume measurement in process plants and plant systems

Dosing and filling of chemical products such as liquid plastics, adhesives, resins, hardeners, potting compounds, solvents, fuels, foams, plasticisers, dyes and paints, oils and synthetic products etc., application in laboratories and manufacturing plants (in normal and explosion-hazardous areas)

Control and regulation of single components, mixing ratios and consumption of various components

Leakage measurement and leakage monitoring on plants

Measurement, indication and logging of data for product quality assurance

Special designs on request

Size	Flow range*		K-factor	
	l/min	GPM	Imp./l	Imp./Gal.
VS 0.02	0.002 ... 2	0.0005 ... 0.53	50,000	189,272.00
VS 0.04	0.004 ... 4	0.0011 ... 1.06	25,000	94,636.00
VS 0.1	0.01 ... 10	0.0026 ... 2.64	10,000	37,854.40
VS 0.2	0.02 ... 18	0.0053 ... 4.76	5,000	18,927.20
VS 0.4	0.03 ... 40	0.0079 ... 10.57	2,500	9,463.60
VS 1	0.05 ... 80	0.0132 ... 21.13	1,000	3,785.44
VS 2	0.1 ... 120	0.0264 ... 31.70	500	1,892.72
VS 4	1 ... 250	0.2642 ... 66.00	250	946.36
VS 10	1.5 ... 525	0.39 ... 138.00	300	1,135.63
	*at 21 cSt	*at 21 cSt		

CALCULATION FACTOR

1 litre = 0.26417 U.S. Gallon

1 U.S. Gallon = 3.78544 litre

1 bar = 14.503684 psi

1 psi = 0.068948 bar

$$^{\circ}\text{C} = \frac{5 \times (^{\circ}\text{F} - 32)}{9} \quad \text{psi} = \text{pound-weight per square inch}$$

$$^{\circ}\text{F} = \frac{9 \times ^{\circ}\text{C} + 32}{5} \quad \text{GPM} = \text{U.S.Gallon per minute}$$

Accuracy	up to 0.3 % of measured value at viscosity > 20 cSt (< 20 cSt reduced accuracy)		
Repeatability	± 0.05 % under same operating conditions		
Materials	Body EN-GJS-400-15 (EN 1563) Stainless Steel 1.4305	Bearings Ball / Plain / Plain (Copper-free) depend on liquid	Seals FPM (standard) NBR, PTFE, EPDM
Max. operating pressures	Cast iron 315 bar/4,568 psi	Stainless steel 450 bar / 6,526 psi	
Medium temperature	Standard Ex-design High temperature	-40 ≤ ... 120° C -20 ≤ ... 100° C (T4) -40 ≤ ... 210° C	
Viscosity ranges	1...100,000 cSt		
Mounting positions	Unrestricted, on subplate with side or bottom connections		
Filtering for ball bearing type	VS 0.02/0.04/0.1 10 µm VS 0.2/0.4 20 µm VS 1/2 50 µm VS 4 50 µm	Exceptions Flow meters with special clearance on request.	
Noise level	Max. 72 dB(A)		
Preamplifier	10 to 28 Volt (DC)		

TECHNICAL DATA

Size	Flow range l/min	GPM	K-Factor Imp./l	Imp./Gal.
VS 10	1.5 ... 525	0.3963 ... 138.69	300	1,135.63

Accuracy	up to 0.3 % of measured value at viscosity > 20 cSt (< 20 cSt reduced accuracy)		
Repeatability	± 0.05 % under same operating conditions		
Materials	Body EN-GJS-600-3 EN 1563	Bearings Ball/Plain gearings depend on liquid	Seals FPM (Standard) NBR, PTFE, EPDM
Max. operating pressure	400 bar/6,000 psi		
Medium temperature	Standard Ex-design High temperature	-40 ≤ ... 120° C -20 ≤ ... 100° C (T4) not available	
Viscosity range	1 ... 100,000 cSt		
Mounting positions	Unrestricted, on subplate with side or bottom connections		
Filtering	50 µm		
Preamplifier	Short circuit proof and reverse polarity proof 10 ... 28 V DC/45 mA, additional current on signal output max. 20 mA		

For precise and exact flow and volume measurements, it is necessary to increase the resolution as high as possible by resolving the measurement V_m , even more than with conventional preamplifiers.

With the VSI-preamplifier versions a selectable resolution of up to 128 flanks (32 pulses) per period can be attained (see table below).

This means that you can resolve the volume measurement V_m with this preamplifier to a maximum of $1/128 V_m$.

For the evaluation, this means that a part volume of $1/128 V_m$ from pulse flank to pulse flank (for quadruple evaluation or flank count) is measured, or a full signal pulse is counted as part volume of $1/32 V_m$ (pulse count).

This individually programmed high resolution enables you to set the volume measurement V_m optimally for each provided case of application. Furthermore, new applications can be availed with the higher resolution

- Measuring, controlling and regulating in lower flow ranges
- Measuring, controlling and regulating in zero flow
- Measuring, controlling and regulating in both flow directions
- Measuring, controlling, dosing and filling of small volumes

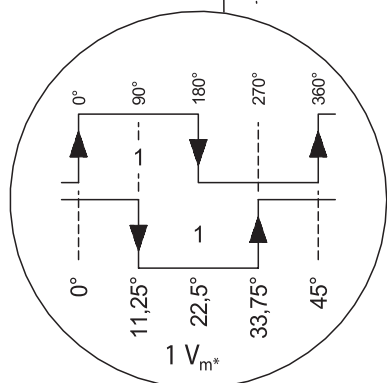
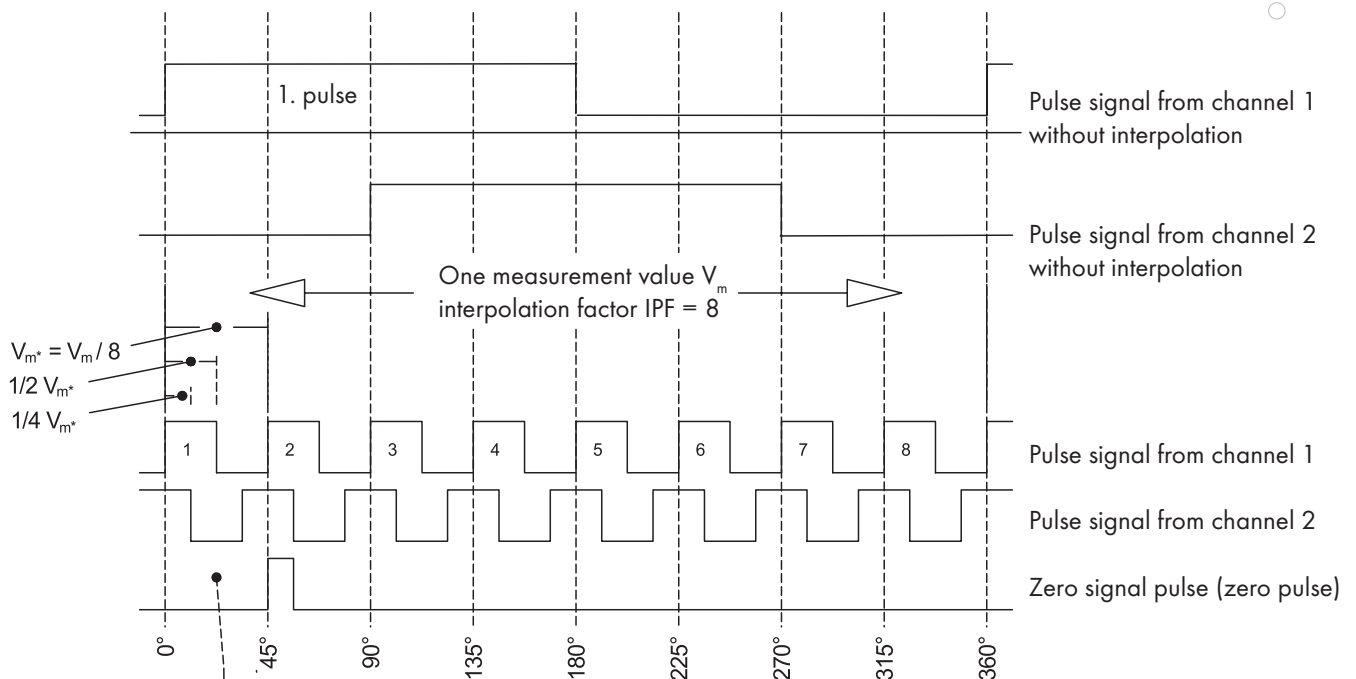

Division of a single pulse into 360° .
 All other signal pulses can be regarded in this way.
 Evaluation electronics recognize flow direction from the channel offset of 90° .
 Each individual pulse flank is offset 90° and has a value of $1/4 V_{m^*}$.

TECHNICAL DATA OF VSI PREAMPLIFIER

Pickup sensor	2 x MR sensor (sine and cosine signals)
Number of sensors	Two pick up sensors for generating the sine and cosine signal
Adjustment	Offset adjustment by two potentiometers
Resolution	Programmable in a range of 1 - 64 flanks per volume measurement V_m
Frequency	Frequency multiplication: programmable in a range of 1 - 16 times the frequency of the pick-up sensors
Output signals	Channel A, channel B, zero channel Z
Channel A and B	Two signal outputs for emitting the digital flow sensor signals; between channel A and channel B there is a channel offset of 90°
Flow direction	Recognition of flow direction from channel offset of the signals from channel A to channel B
Zero signal Z	Zero signal, marks the flow of one volume measurement V_m
Outputs	3 current limiting and short-circuit-proof push-pull output stages (channel A, channel B, zero signal Z); driver current approx. 300 mA at 24 V power supply; small saturation voltage up to 30 mA load current; short switching times; reverse voltage protection by integrated free-run diodes against V_b and GND; temperature protection switching with hysteresis; outputs are of high impedance in case of error; ESD protected
Operating voltage	$V_b = 10 \dots 28$ VDC
Current consumption	$I_{no\ load} =$ approx. 40 mA; total current consumption depending on loading of outputs



TECHNICAL DATA OF VSI PREAMPLIFIER – UPGRADE (HIGH PERFORMANCE)

Pickup sensor	2 x MR-sensor (sine and cosine signals)
Configuration	automatically via peripheral board
Resolution	programmable 1, 2, 3, 4, 5, 8, 10, 12, 16, 24, 32
Frequency	up to 100kHz
Output signals	Channel A, channel B, direction signal „DIREC“ (high positiv; low negativ)
Channel A and B	Two signal outputs for emitting the digital flow sensor signals; between channel A and channel B there is a channel offset of 90°
Flow direction	Recognition of flow direction from channel offset of the signals from channel A to channel B or from the separate direction signal on pin 5, direction can be changed by the preamplifier electronics
Outputs	3 current limiting and short-circuit-proof push-pull output stages (channel A, channel B, DIREC); driver current approx. 200 mA at 24 V power supply; small saturation voltage up to 30 mA load current; short switching times; reverse voltage protection by integrated free-run diodes against V_b and GND; temperature protection switching with hysteresis; outputs are of high impedance in case of error; ESD protected
Error messages	Electronics error (e.g. defective interpolator); sensor error(e.g. sensor break-off); configuration necessary; overload (flow peaks)
Operating voltage	$V_b = 10 \dots 28$ VDC
Current consumption	$I_{no\ load} =$ approx. 65 mA; total current consumption depending on loading of outputs

ADVANTAGES

Easy replaceable, Upgrade for standard VS, higher resolution, more stability under harsh conditions



INTERPOLATION FACTOR AND RESOLUTION

Interpolation factor	Imp/V _m	Max. resolution (evaluation of signal flanks)	Resolution V _m * (volume measurement V _m *) [ml]	Max. resolution (angle degrees)	Frequency f _{max} *
1	1	4 (quadrupling)	V _m / 4	90°	f _{max} x 1
2	2	8	V _m / 8	45°	f _{max} x 2
3	3	12	V _m /12	30°	f _{max} x 3
4	4	16	V _m /16	22.5°	f _{max} x 4
5	5	20	V _m /20	18°	f _{max} x 5
8	8	32	V _m /32	11.25°	f _{max} x 8
10	10	40	V _m /40	9°	f _{max} x 10
12	12	48	V _m /48	7.5°	f _{max} x 12
16	16	64	V _m /64	5.625°	f _{max} x 16
24*	24	96	V _m /96	3.75°	f _{max} x 24
32*	32	128	V _m /128	2.8125°	f _{max} x 32

*Only VSI upgrade version

Column 1: Programmable interpolation factor IPF (programming is done in the factory)

Column 2: Pulses per volume measurement V_m

Column 3: Maximum resolution of the signal flanks. The signal flanks channels 1 and 2 are evaluated

Column 4: Volume measurement V_m* resulting from the maximum resolution of the signal flanks

Column 5: Maximum resolution in angle degrees at resolution of signal flanks

Column 6: Maximum frequency f_{max}* at maximum flow Q_{max} and programmed interpolation factor IPF

In practice the maximum flow Q_{max} of the flow meter is seldom run so that a lower frequency can be calculated. The maximum frequency is then calculated according to the following formula:

$$f_{\max} = \frac{(Q_{\max})^* \text{IPF}}{V_m} \quad \text{formula 1}$$

f_{max}* Maximum frequency of the flow meter signals

Q_{max} Maximum flow attained in the case of application described here

IPF Programmed interpolation factor

V_m Volume measurement of the flow meter

Example Flow meter VSI 1/10... max. flow rate of the system at maximum capacity

$$\begin{aligned} Q &= 40 \text{ l/min} = 666.667 \text{ ml/sec}; \text{ IPF} = 10; \\ V_m^{\max} &= 1 \text{ ml/pulse}; f_{\max}^* = 6666.67 \text{ Hz} \\ &= 6.66667 \text{ kHz} \end{aligned}$$

At max. flow $f_{\max}^* = 40 \text{ l/min}$, the flow meter VSI 1/10... outputs a frequency of

$$f_{\max}^* = 6666.67 \text{ Hz.}$$

FLOW RESPONSE CURVES

VS(I) 0.02

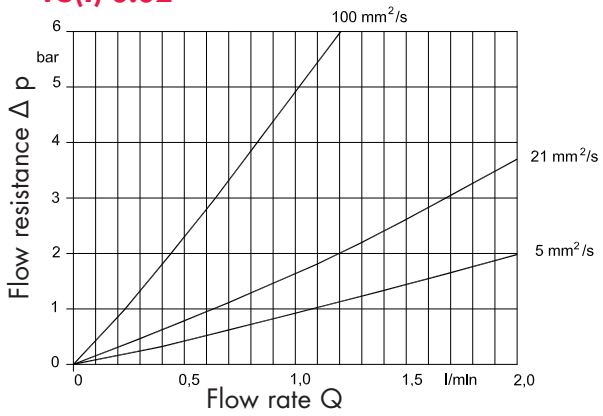

VS(I) 0.04

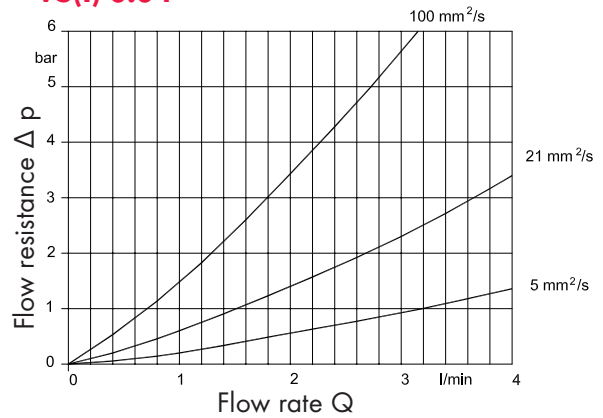

VS(I) 0.1

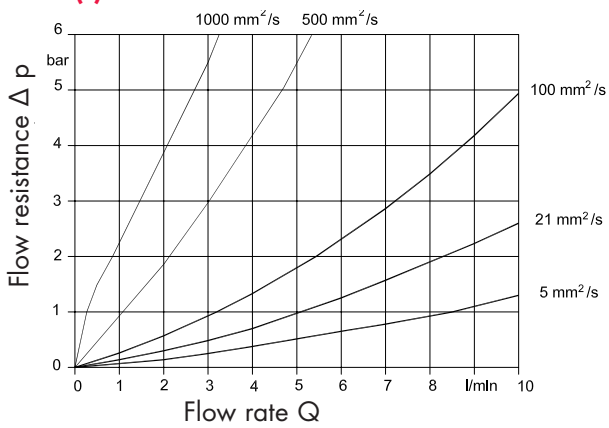

VS(I) 0.2

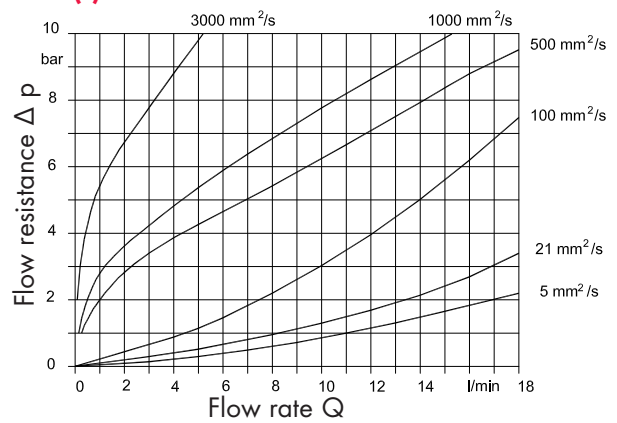

VS(I) 0.4

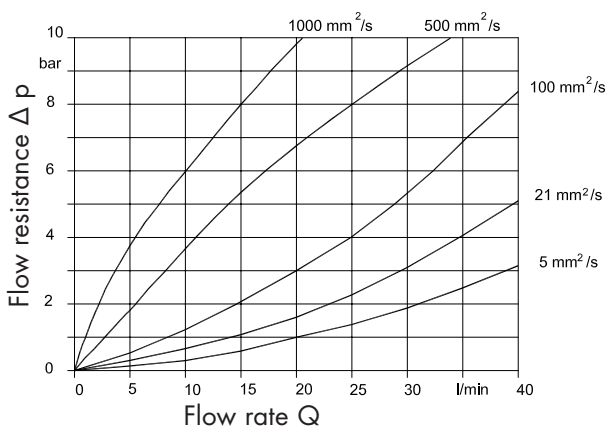

VS(I) 1

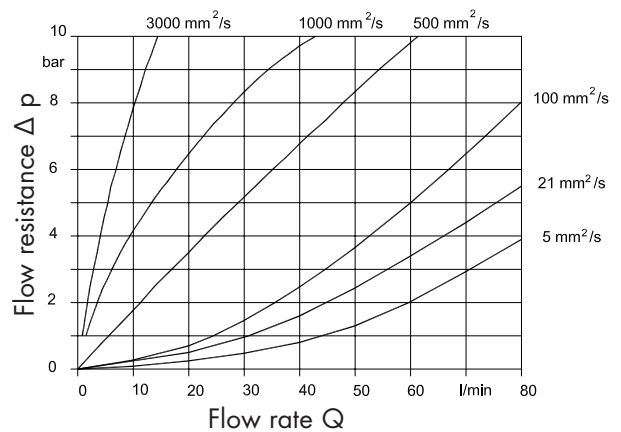

FLOW RESPONSE CURVES

VS(I) 2

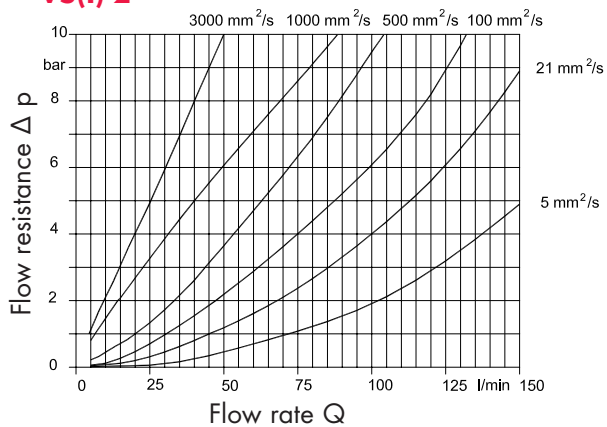

VS(I) 4

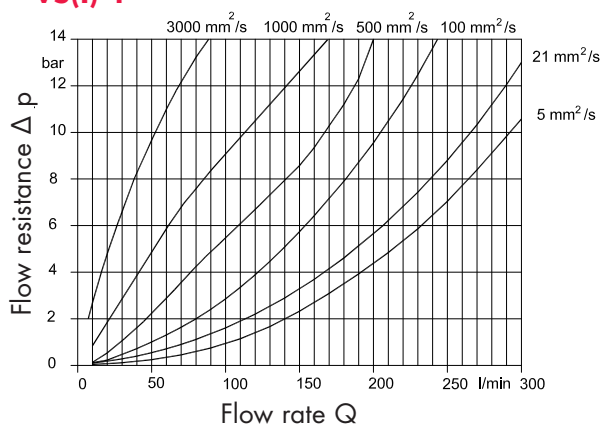

VS(I) 10

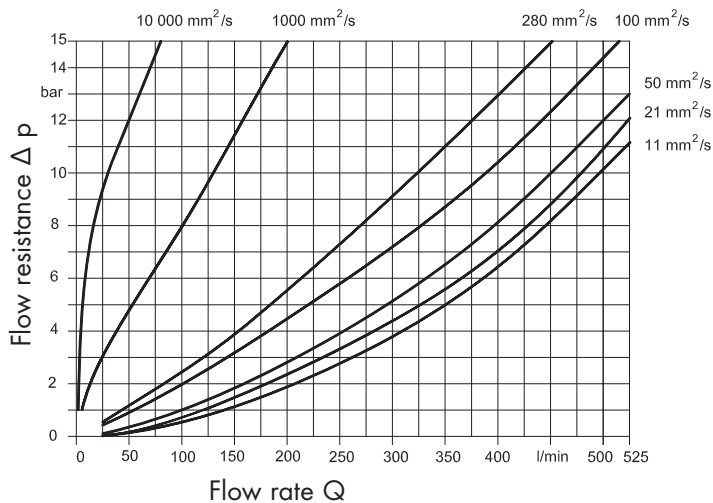

VS(I) FLOW METER DIMENSIONS

VS(I) 0.02 ... VS(I) 4

CAST IRON VERSION

Housing curve mill cutted

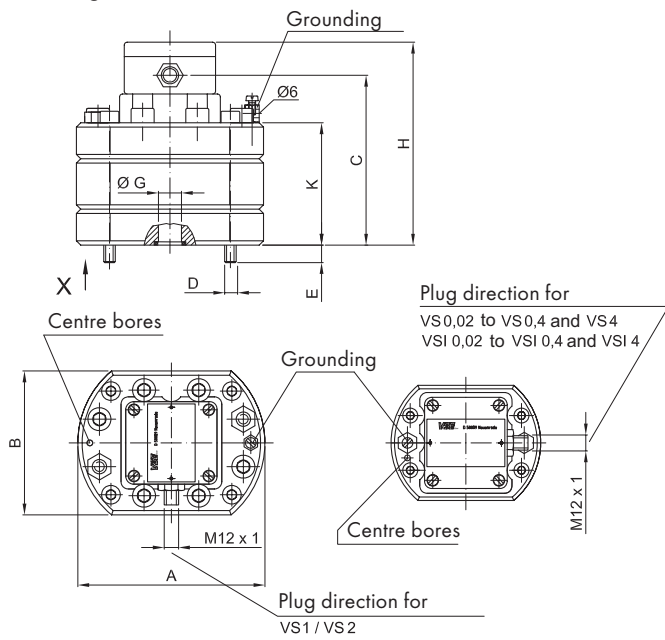

CAST IRON VERSION

CONNECTION DRAWING

View X

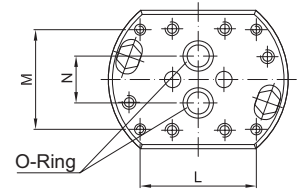

STAINLESS STEEL VERSION

CONNECTION DRAWING

Housing not mill cutted

View X

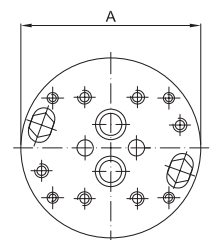

Size VS/ VSI	A	B	C	D	E	ø G	H	K	L	M	N	O-Ring	Weight		
													GG*	E**	
													kg	kg	
0.02	100	80	91	M 6	12	ø 9	114	58	70	40	20	11	x 2	2.8	3.4
0.04	100	80	91.5	M 6	11.5	ø 9	114.5	58.5	70	40	20	11	x 2	2.8	3.4
0.1	100	80	94	M 6	9	ø 9	117	61	70	40	20	11	x 2	2.8	3.4
0.2	100	80	93.5	M 6	9.5	ø 9	116.5	60.5	70	40	20	11	x 2	3.0	3.7
0.4	115	90	96.5	M 8	11.5	ø 16	119.5	63.5	80	38	34	17.96	x 2.62	4.0	5.0
1	130	100	101	M 8	12	ø 16	124	68	84	72	34	17.96	x 2.62	5.3	6.8
2	130	100	118	M 8	15	ø 16	141	85	84	72	34	17.96	x 2.62	6.7	8.4
4	180	140	143	M 12	20	ø 30	166	110	46	95	45	36.17	x 2.62	14.7	18.4

*GG= Cast Iron EN-GJS-400-15 (EN 1563)

** E = Stainless Steel 1.4305

Dimensions are specified in mm

DIMENSIONS VS(I) 10

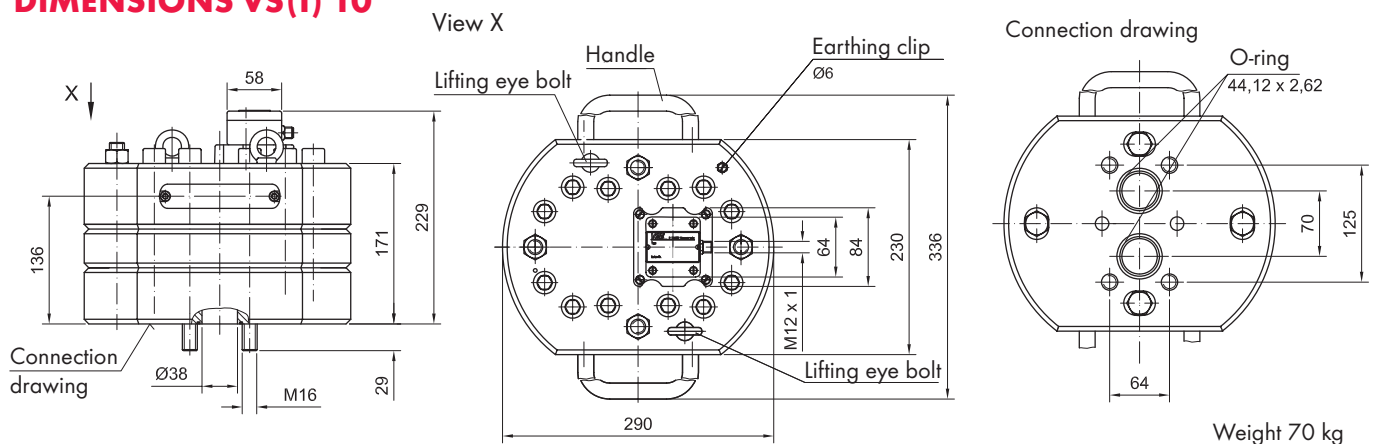

SIDE PORTS

BOTTOM PORTS

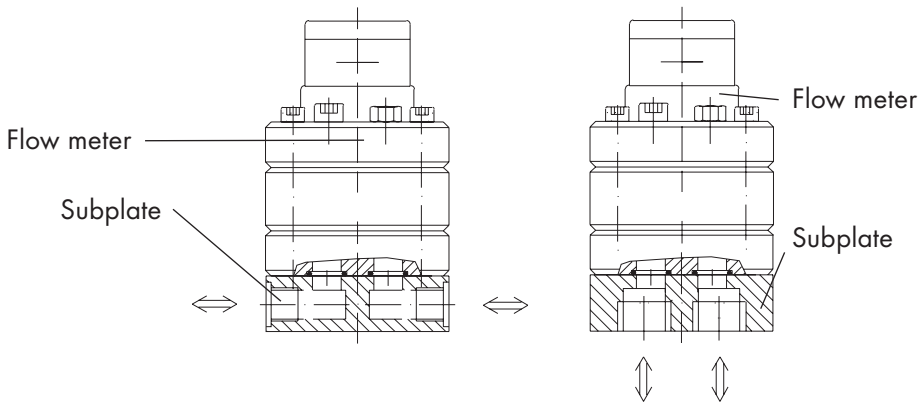

AP SUBPLATE DIMENSIONS

Side ports

Bottom ports*

Cast iron / APG.S.../.

Stainless steel / APE.S.../.

Cast iron / APG.U.../.

Stainless steel / APE.U.../.

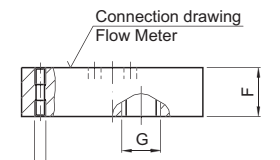
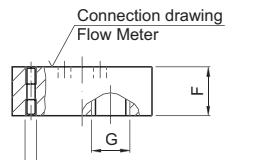
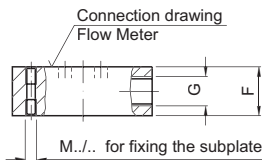
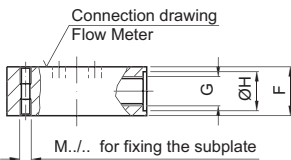
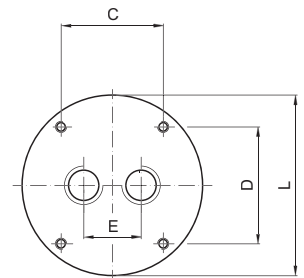
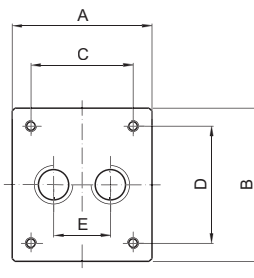
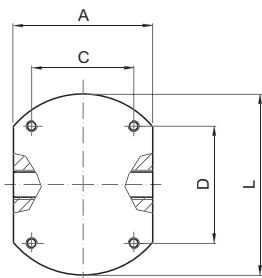
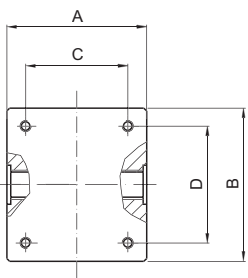

* Both bottom ports (G) for size APG 4 U and APE 4 U have a displacement of 90° to the shown drawings.

APG 10 S GON/1

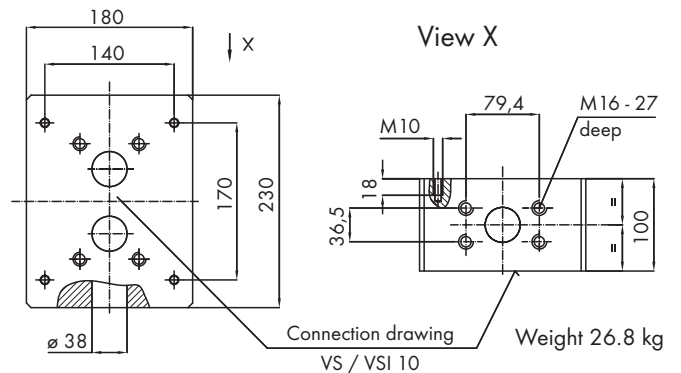
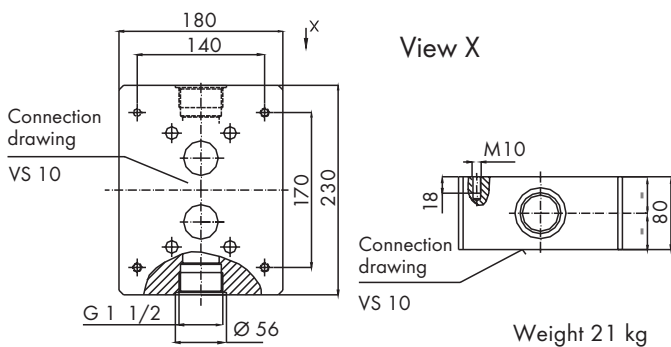

Dimensions are specified in mm

Affiliated size	VS/VSI	G pipe thread classification	G	F	ø H	E ^①
	0.02 / 0.04 0.1 / 0.2		G 1/4	35	ø 20	26
	0.02 / 0.04 0.1 / 0.2		G 3/8	35	ø 23	30
	0.02 / 0.04 0.1 / 0.2		G 1/2	35	ø 28	38
	0.4 / 1 / 2		G 1/2	35	ø 28	46
	0.4 / 1 / 2		G 3/4	40	ø 33	52
	1 / 2		G 1	55	ø 41	55
	4		G 1 1/4	70	ø 51	60
	4		G 1 1/2	AP..U=70	ø 56	72
	4		G 1 1/2	AP..S=80	ø 56	72

Size							Depth	Weight
VS/VSI	AP	A	B	C	D	L ^②	M	kg
0.02/0.04 0.1/0.2	AP.02	80	90	40	70	100	M6/12	1.8
0.4	AP.04	90	100	38	80	115	M8/15	2.7
1/2	AP.1	100	110	72	84	130	M8/15	3.6
4	APG4	120	130	100	110	-	M8/15	7.4
	APG4 UG	140	120	120	100	-	M8/15	7.4
	APE.4	140	-	100	110	180	M8/15	12

① Only for APG.U .../. ; APE.U .../.

② Only for APE.S .../. ; APE.U .../.

Special designs on request

VSE FLOW METERS IN EX-DESIGN / THE BARRIER AMPLIFIER

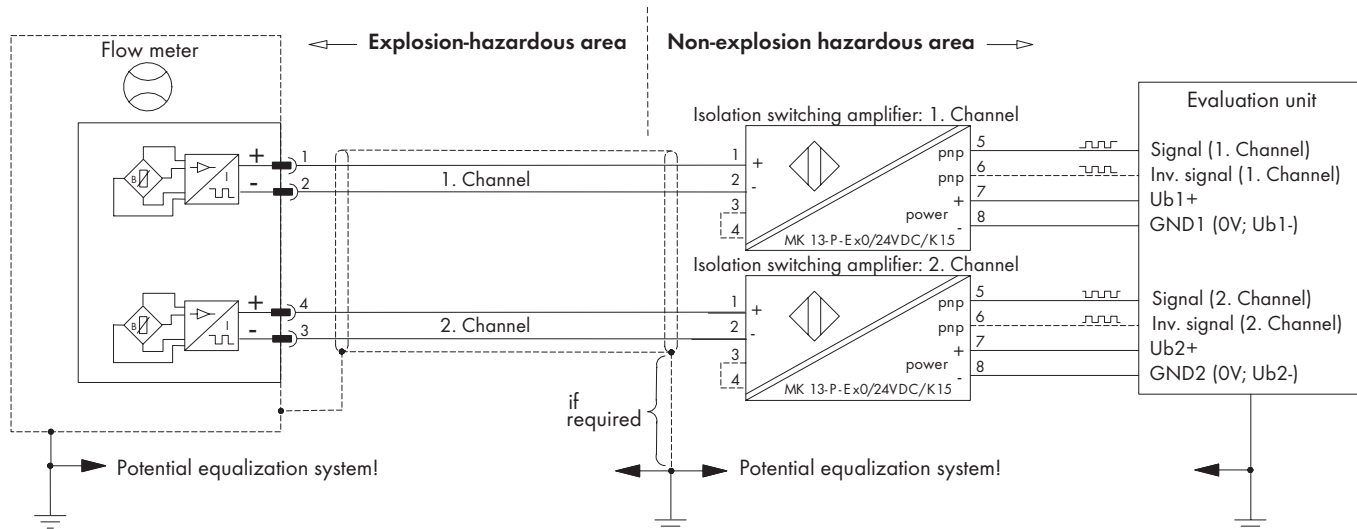

VSE FLOW METERS IN EX-DESIGN

The VSE flow meters of the VS series in Ex-design are approved for applications in potentially explosion-hazardous areas and are always operated in conjunction with barrier amplifiers. They have blue markings and offer the necessary Ex-protection security. The type plate shows the necessary description according to DIN EN 60079, the type key and the safety-related and electric data. VSE can supply the flow meters with the barrier amplifiers type MK 13-P-Ex 0/24 VDC/K15.

THE BARRIER AMPLIFIER MK 13-P-EX 0 / 24 VDC / K15

The barrier amplifier MK 13-P-Ex 0/24 VDC/K15 enables an isolated transmission of binary

switching status. It has an intrinsically safe control circuit and is certified according to $\text{Ex II}(1) \text{GD [EEx ia] II C}$.

There is a galvanic separation from the control circuit to the output circuit and to the power supply. For the transmission of two channels, two barrier amplifiers of this version are necessary. The control circuit can be monitored concerning wire breaking and short circuit (the monitoring can be switched off via a wire jumper).

An error in the control circuit stops the signal output. One plus-switching short circuit proof transistor output (PNP-output) provides the digital signal of the connected channel.

Flow meter	VSE connection cable, blue	Barrier amplifier						
Type VS **** -32 Q1 * / *	Shielded; 4 x 0.34 mm²	Type MK 13-P-Ex 0 / 24 VDC / K15						
BVS 05 ATEX E 071 X	PUR	PTB 06ATEX 2025						
$\text{Ex II 1G Ex ia II C T4-T6}$		$\text{Ex II}(1) \text{GD [EEx ia] II C}$						
$U_i = 18.5 \text{ V}$	$R = 0.053 \text{ } \Omega/\text{m}$	$U_o = 9,9 \text{ V}$						
$I_i = 24 \text{ mA}$	$L = 0.85 \text{ } \mu\text{H}/\text{m} \text{ (x)}$	$I_o = 22 \text{ mA}$						
$P_i = 100 \text{ mW}$	$C_{A-A} = 55 \text{ pF}/\text{m} \text{ (x)}$	$P_o = 54 \text{ mW}$						
$R_i = 0$	$C_{A-S} = 105 \text{ pF}/\text{m} \text{ (x)}$							
$L_i = 0$	$[(x) = \text{Measured at } 1000 \text{ Hz}]$							
$C_i = 0.27 \text{ } \mu\text{F}$								
		IIC						
		IIB						
		Lo/mH	1	5	10	2	10	20
		Co/ μF	1.1	0.75	0.65	5	3.5	3

Temperature class	T4	T5	T6
Ambient temperature	$-20^\circ\text{C} \leq T_{\text{amb}} \leq 95^\circ\text{C}$	$-20^\circ\text{C} \leq T_{\text{amb}} \leq 70^\circ\text{C}$	$-20^\circ\text{C} \leq T_{\text{amb}} \leq 55^\circ\text{C}$
Liquid temperature	$-20^\circ\text{C} \leq T_{\text{Med}} \leq 100^\circ\text{C}$	$-20^\circ\text{C} \leq T_{\text{Med}} \leq 75^\circ\text{C}$	$-20^\circ\text{C} \leq T_{\text{Med}} \leq 60^\circ\text{C}$

PICK-UP SYSTEM FOR HIGH TEMPERATURE RANGES



OPTION FOR STAINLESS STEEL FLOW METERS VS 0.04 ... VS 4

The pick-up system consists of one or two sensor units, which are screwed into the cover of the VS flow meter and of a downstream switched amplifier. This amplifier is connected with the flow meter by means of a temperature resistant cable and has to be installed outside the high temperature area, where the ambient temperature should not exceed 50°C.

The following pictures show the respective connection of the electronic readout.

For long cable lengths and high input impedance of the readout, it is recommended to use shielded cables.

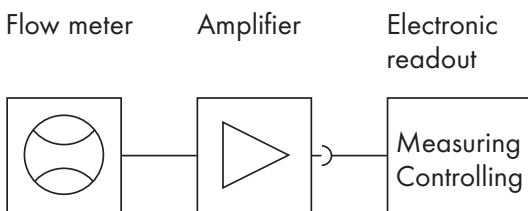

CONNECTION DIAGRAMS

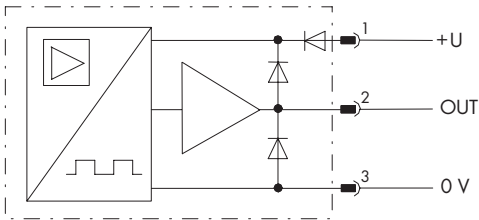

Pulse output PP-version

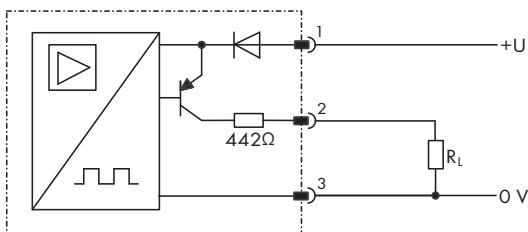

Pulse output PNP-version

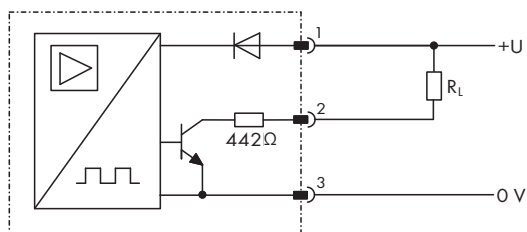

Pulse output NPN-version

TECHNICAL DATA / FLOW METER DIMENSIONS

TECHNICAL DATA: SENSOR UNIT

Medium temperature	-40° C ... 210° C
Number of pick-ups	1 or 2 pick-ups
Pick-up	Magnetostrictive
Electrical connection	cable gland
Seals	FPM or EPDM

TECHNICAL DATA: AMPLIFIER

Supply voltage	$U_b = 10 \dots 30 \text{ V DC } \pm 10\%$
Current consumption	$I_b = \text{approx. } 18 \text{ mA}$ (idle motion, without load)
Signal output PP (Push-Pull)	High Sign.: $U_s = U_b - 1,5 \text{ V}$; Low Sign.: $U_s = 0 \text{ V}$; $I_s = 100 \text{ mA max}$
Signal output PNP	High sign: $U_s = U_b - 1 \text{ V}$; $I_s = 25 \text{ mA max}$
Signal output NPN	Low sign: $U_s = 0 \text{ V}$; $I_s = 25 \text{ mA max}$
Electrical connection	4 pin round plug M12
Max. ambient temperature	-20° C ... 50° C
Protection class	IP 64

FLOW METER DIMENSIONS

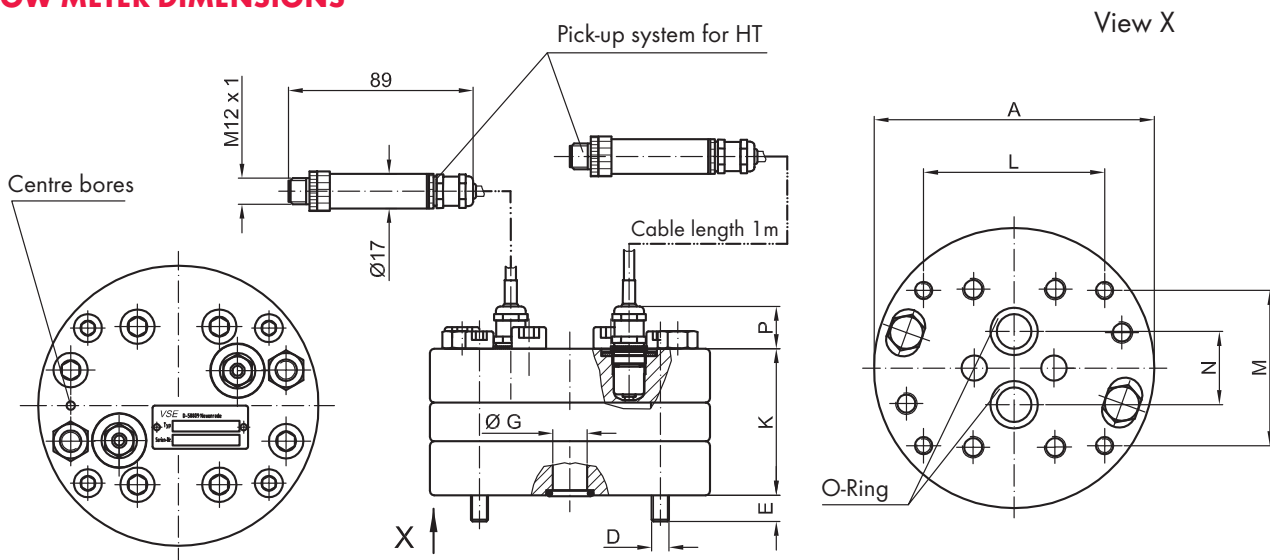

Size	A	D	E	Ø G	K	L	M	N	P	O-Ring	Weight kg
VS 0.04*	100	M 6	11.5	Ø 9	58.5	70	40	20	22	11 x 2	3.5
VS 0.1	100	M 6	9	Ø 9	61	70	40	20	22	11 x 2	3.3
VS 0.2	100	M 6	9.5	Ø 9	60.5	70	40	20	22	11 x 2	3.6
VS 0.4	115	M 8	11.5	Ø 16	63.5	80	38	34	22	17.96 x 2.62	4.9
VS 1	130	M 8	12	Ø 16	68	84	72	34	22	17.96 x 2.62	6.7
VS 2	130	M 8	15	Ø 16	85	84	72	34	22	17.96 x 2.62	8.3
VS 4	180	M 12	20	Ø 30	110	46	95	45	12	36.17 x 2.62	18.3

*Attention: 0.04 with one (1) channel only

SUBPLATES AP

SUBPLATES AP

EXAMPLE

A	P	G	1	-	S	C	0	N	/	X															
Subplate					Connection thread		0	N S		X	Modification Id. No.														
												Accessory connection	Version	Product line											
															Standard version										
															Special version										
												Without rinse connection													
												Side connection													
																								A	G 1/4
																								B	G 3/8
																								C	G 1/2
																								D	G 3/4
					E	G 1																			
					F	G 1 1/4																			
					G	G 1 1/2																			
					J	1/4 NPT																			
					K	3/8 NPT																			
					L	1/2 NPT																			
					M	3/4 NPT																			
					N	1 NPT																			
					O	1 1/4 NPT																			
					P	1 1/2 NPT																			
S	SAE 1/2																								
T	SAE 3/4																								
U	SAE 1																								
V	SAE 1 1/4																								
W	SAE 1 1/2																								
X	SAE 2																								
Size																									
												S	Side connection												
Material																									
												U	Bottom connection												
												0,2	VS 0,02 to VS 0,2 / VSI 0,02 to VSI 0,2												
												0,4	VS 0,4 / VSI 0,4												
												1	VS 1 / VS 2 / VSI 1 / VSI 2												
4	VS 4 / VSI 4																								
10	VS 10 / VSI 10																								
Subplate																									
												G	EN-GJL-250, EN-GJS-400-15 DIN EN 1561/ 1563												
												E	Stainless steel 1.4305												
H	EN-GJS-600-3 DIN EN 1563 (high pressure)																								

TYPE KEY FLOW METERS VSI

EXAMPLE

VSI 1	/	4	G	P	O	1	2	V	-	3	2	W	1	5	/	X	..
Size	Interpolation	for VSI 0.02 to VSI 4	G	P	O	1	2	V	-	3	2	W	1	5	/	X	Product line
																	Power supply voltage
																	10 ... 28 V
																	Power supply volt.
																	X
																	Modification id. No.
																	1
																	5
																	VSE norm connection (4-pole)
																	5-pole plug connection
																	1
																	Integrated (standard design)
																	W
																	VV int. WE (power supply volt. 10 ... 28 V DC)
																	2
2 Sensors																	
3																	
GMR- Sensor																	
V																	
P																	
T																	
E																	
B																	
S																	
FPM (Viton) standard																	
NBR (Perbunan)																	
PTFE																	
EPDM																	
EPDM - 41B8																	
Silicone																	
1																	
2																	
3																	
4																	
Reduced tolerance																	
Normal tolerance (standard)																	
Increased tolerance																	
Tolerance steel plain bearing																	
1																	
2																	
3																	
4																	
5																	
Ball bearings																	
Spindle bearings																	
Bronze plain bearings																	
Carbon bearings																	
Steel bearings																	
O																	
C																	
T																	
No coating (standard)																	
Dynamat coating (C-coating)																	
Titanium coating																	
P																	
R																	
Plate construction																	
Pipeline connections																	
G																	
E																	
H																	
EN-GJS-400-15 (VSI10 = EN-GJS-600-3) DIN EN 1563																	
Stainless steel 1.4305 (V2A)																	
EN-GJS-600-3 (High pressure) DIN EN 1563																	
1	1 Imp. pro V_z	$V_m = V_z$ pro Imp	1	3 Imp. pro V_z	$V_m = 10/3$ pro Imp												
2	2 Imp. pro V_z	$V_m = V_z/2$ pro Imp.	2	6 Imp. pro V_z	$V_m = 10/6$ pro Imp.												
3	3 Imp. pro V_z	$V_m = V_z/3$ pro Imp.	3	9 Imp. pro V_z	$V_m = 10/9$ pro Imp.												
4	4 Imp. pro V_z	$V_m = V_z/4$ pro Imp.	4	12 Imp. pro V_z	$V_m = 10/12$ pro Imp.												
5	5 Imp. pro V_z	$V_m = V_z/5$ pro Imp.	5	15 Imp. pro V_z	$V_m = 10/15$ pro Imp.												
8	8 Imp. pro V_z	$V_m = V_z/8$ pro Imp.	8	24 Imp. pro V_z	$V_m = 10/24$ pro Imp.												
10	10 Imp. pro V_z	$V_m = V_z/10$ pro Imp.	10	30 Imp. pro V_z	$V_m = 10/30$ pro Imp.												
12	12 Imp. pro V_z	$V_m = V_z/12$ pro Imp.	12	36 Imp. pro V_z	$V_m = 10/36$ pro Imp.												
16	16 Imp. pro V_z	$V_m = V_z/16$ pro Imp.	16	48 Imp. pro V_z	$V_m = 10/48$ pro Imp.												
VSI 0.02	$V_z = 0.02$ ml																
VSI 0.04	$V_z = 0.04$ ml																
VSI 0.1	$V_z = 0.1$ ml																
VSI 0.2	$V_z = 0.2$ ml																
VSI 0.4	$V_z = 0.4$ ml																
VSI 1	$V_z = 1$ ml																
VSI 2	$V_z = 2$ ml																
VSI 4	$V_z = 4$ ml																
VSI 10	$V_z = 10$ ml																
				$V_m =$ Volume (cm ³)													
				$V_z =$ the volume between the gear teeth													

FLOW RATE MEASURING INSTRUMENT MF1 FOR 2-CHANNEL FLOW SENSOR



Flow direction indication with switching output
(0 V/5 V)

2 optocoupler limit value outputs, limit values are individually programmable

Analogue output with flow rate direction dependent voltage-/current-polarity is available

0 ... (\pm) 10 V

0 ... (\pm) 20 mA

4 ... 20 mA

A power supply for flow sensor is integrated
24 Volt DC/50 mA

UNIVERSAL MEASURING INSTRUMENT VFM 320 FOR DYNAMIC PROCESS MEASUREMENTS AND CLOSED LOOP CONTROLS



Flow rate, volume and ratio measurements as well as measurement and control of volume-shots or mass-shots in 2-component mixing systems

Signal processing of 2 flow sensors with 2-channel signal outputs

2 independent dynamic analogue outputs with 16 Bit digital-analogue converter D/A-converter:

<3 ms (0 Hz \rightarrow 2 kHz \rightarrow 0 Hz)

The flow rate and volume values are direction dependent

(0 V $\xleftarrow{\text{Flow in direction 2}}$ 5 V $\xrightarrow{\text{Flow in direction 1}}$ 10 V)

or direction independent

(10 V $\xleftarrow{\text{Flow in direction 2}}$ 0 V $\xrightarrow{\text{Flow in direction 1}}$ 10 V)

Real time output of analogue and digital measurement values

PC-Interface 1 x RS 232, 2 x RS 485

Special designs on request

FLOW RATE MEASURING INSTRUMENT A341-28



The evaluation electronics A341-28 simultaneously records two independent flows via flow meters and is suitable for incremental rotary transducers, proximity switches, etc.

Two individually scalable pulse inputs for 1, 2 or 4 tracks (A, /A, B, /B), suitable for input frequencies of 0.01 Hz to 1 MHz per channel

Single measurement, sum or differential measurement, ratio or percentage deviation, etc.

Linearisation function for each flow measurement

5 independent parameter sets presettable

14-bit analogue output; 0/4 ... 20 mA, 0 ... 10 V and -/+ 10 V; <1 ms reaction time

4 limit value settings with very fast responding transistor switch outputs

Programmable via an RS232 interface

2x encoder supply 24 VDC/120 mA

Standard housing 96 x 48 mm and protection class IP65

DISPLAY A350-28



The A350-28 is a multifunctional device for flow and volume measurement.

Universal inputs (HTL/RS422) for encoders / VSE flow meters

186 x 64 pixel graphic display with touch function

Bright, high-contrast display with result-based colour options

Emulation of a 7-segment display with symbols and units

Intuitive and easy parameterisation using plain text and touchscreen or via a RS232 interface

Auxiliary voltage output 5/24 VDC for encoder supply

Input frequency up to 1 MHz

Linearisation with 24 support points

16 bit analog output 0/4 ... 20 mA, 0 ... 10 V and -/+ 10 V; 20 ms reaction time

Numerous functions such as scaling, filters, startup bridging

Standard installation housing with 96 x 48 mm and protection class IP65

SIGNAL CONVERTER FU210



Operating modes as frequency converter
or pulse counter

Conversion time only < 1msec

16 Bit resolution (accuracy 0.1%)

Selectable analogue output: ± 10 V, 0/4...20mA

Programmable linearisation with 24 points

6 control inputs and 6 control outputs

Power supply 18 ... 30 VDC

Easy parameterisation by user interface

EASYLOADER or OS 6.0 via USB or RS232

INSTRUMENTS FOR IMPULSE CONDITIONING

FREQUENCY-/ANALOGUE CONVERTER DIGFU 1



Converter output signal for operation with 1-channel flow sensor

0 ... 10 V

0 ... 20 mA

4 ... 20 mA

Converter output signal with flow direction polarity for operation with 2-channel flow sensor

0 ... \pm 10 V

0 ... \pm 20 mA

Evaluation of flow direction via digital output signal possible if a 2-channel flow sensor is connected

Proportional to flow frequency a digital output

frequency signal with multiplier factor is adjustable

SIGNAL CONVERTER PGW-1 FOR 2- OR 1- CHANNEL FLOW SENSORS TO CONVERT FLOW SENSOR OUTPUT SIGNALS INTO OTHER VOLTAGE LEVELS



For example: for chart recorder with impulse input, forward-/reversecounter, computer, PC- and PLC controls

Available output voltages:

TTL 5 V, 8 V, 12 V, CMOS 15 V

Power supply/current consumption:

10 ... 30 V DC, 20 mA without flow sensor

Inverted and non-inverted output signal for both channels integrated among other things for connection on differential count inputs to achieve a distortion-free signal transmission over long cable distances

BARRIER AMPLIFIER MK-13



Economical interfaces with galvanic isolation between intrinsically safe and non-intrinsically safe circuits

Must be installed in the safe area

Are used to limit the electrical power into an intrinsically safe circuit in such a way that neither sparks nor thermal effects (hot surfaces) can cause an ignition

Connection diagram and exact type no. see page 16

PRODUCT OVERVIEW



RS SERIES

0 - 3,000 l/min



VHM SERIES

0.01 - 20 l/min



EF ECOFLOW SERIES

0.05 - 150 l/min



VTR SERIES

110 l/h - 4,500 m³/h



SPECIAL OPTIONS

distributed by

VSE.flow®

VSE Volumenteknik GmbH
Hönnestraße 49
58809 Neuenrade / Germany

Phone +49 (0) 23 94 / 616-30

Fax +49 (0) 23 94 / 616-33

info@vse-flow.com

www.vse-flow.com



e.holding
FLUID TECHNOLOGY GROUP
www.e-holding.de